



# MTA, CST-100 II, SL-156 and AMP Economy Power (EP) Connectors

## Table of Contents

### Introduction

This catalog has been designed to assist you, our customer, identify products to satisfy your connector needs for printed circuit board headers, mass termination connectors preloaded with contacts, crimp-snap contacts and housings, and card edge connectors with preloaded contacts.

The list at right identifies by centerline the types of product available and is meant to be of assistance to you in the product selection process.



**IDC**  
**MTA-50**



**IDC**  
**MTA-100**



**Crimp**  
**CST-100 II**



**IDC**  
**MTA-156**

© 1977, 1978, 1979, 1980, 1983, 1986, 1988, 1992, 1993, 1994, 1995, 1999, 2000, 2001, 2002, 2003 and 2005 by Tyco Electronics Corporation.

All International Rights Reserved.  
AMP, AMP-O-LECTRIC, AMP-O-MATIC, AMPOMATOR, CERTI-CRIMP, PRO-CRIMPER, MADISON CABLE and TYCO are trademarks.

TEFLON is a trademark of E.I. DuPont De Nemours and Company.

Other products, logos, and company names mentioned herein may be trademarks of their respective owners.

<b>Introduction and Table of Contents</b> .....	2, 3
<b>Connector Selection Guide</b> .....	3
<b>.050 [1.27] Centerline Connectors</b>	
<b>MTA-50 IDC Connectors and Headers</b> .....	4-10
Introduction and Wire-to-Board Mateability Guide .....	4
IDC Connector Kits (Feed-Thru and Closed End)	
Ribbon Cable .....	5, 6
Discrete Wire .....	7, 8
Through-Hole Header Assemblies	
Vertical and Right-Angle .....	9
Surface Mount Header Assemblies	
Vertical and Right-Angle .....	10
<b>.100 [2.54] Centerline Connectors</b>	
<b>MTA-100 IDC Connectors and Headers</b> .....	11-31
Introduction .....	11
Wire-to-Board Mateability Guide .....	12, 13
Connectors—UL94V-2 and UL94V-0	
Closed End with and without Polarizing Tab .....	14, 15
Feed-Thru with and without Polarizing Tab .....	14, 15
LED Closed End and Feed-Thru—UL94V-2 .....	14, 15
Accessories .....	16, 17
Posted Connectors Mateability Guide .....	18, 19
MTA-100 Posted Connectors (Wire-to-Wire) UL94V-2	
Closed End .....	20
Feed-Thru .....	20
Headers—UL94V-0	
Flat—Straight and Right-Angle Posts .....	21
Narrow Flat—Straight and Right-Angle Posts .....	22
Polarized—Straight and Right-Angle Posts .....	23
Friction Lock—Straight and Right-Angle Posts .....	24
Headers with Retention Peg—Straight Posts .....	25
High Profile Headers—Right-Angle Posts .....	26
Polarized—High Temperature, Straight and Right-Angle Posts .....	27
Friction Lock—High Temperature, Straight and Right-Angle Posts .....	28
Polarized—Surface Mount, Straight .....	29
Friction Lock—Surface Mount, Straight .....	29
Shrouded—Straight and Right-Angle Posts .....	30
<b>CST-100 II Crimp Contacts, Housings and Shrouded Headers</b> .....	31, 32
<b>.156 [3.96] Centerline Connectors</b>	
<b>MTA-156 IDC Connectors and Headers</b> .....	33-57
Introduction .....	33
Wire-to-Board Mateability Guide .....	34, 35
Connectors—UL94V-2 and UL94V-0	
Closed End with Locking Ramp, with and without Polarizing Tabs .....	36, 37
Closed End without Locking Ramp, with and without Polarizing Tabs .....	36, 37
Feed-Thru with Locking Ramp, with and without Polarizing Tabs .....	38, 39
Feed-Thru without Locking Ramp, with and without Polarizing Tabs .....	38, 39
Accessories .....	40-42
Posted Connectors Mateability Guide .....	43, 44
MTA-156 Posted Connectors (Wire-to-Wire)—UL94V-2	
Closed End .....	45
Feed-Thru .....	45
MTA-156 Headers—UL94V-0	
Flat—Straight Posts .....	46
Flat—Right-Angle Posts .....	47
Friction Lock—Straight Posts .....	48
Friction Lock—Right-Angle Posts .....	49
Polarized Lock—Straight Posts .....	50
Polarized Lock—Right-Angle Posts .....	51
Friction Lock—High Temperature, Straight Posts .....	52
Shrouded—Straight and Right-Angle Posts .....	53
<b>MTA-156 Quad Connectors—UL94V-0</b> .....	54, 55
Closed End with Locking Ramp .....	55
Feed-Thru with Locking Ramp .....	55

**Table of Contents** (Continued)



**Crimp  
SL-156**



**Crimp  
AMP EP Connectors**

**Need more information?**

Call Technical Support at the numbers listed below.

Technical Support is staffed with specialists well versed in Tyco Electronics products. They can provide you with:

- Technical support
- Catalogs
- Technical Documents
- Product Samples
- Authorized Distributor Locations

**MTA-156 Card Edge** . . . . . 56, 57  
 Connectors — UL94V-0  
     Closed End with and without Mounting Ears . . . . . 56  
     Feed-Thru with and without Mounting Ears . . . . . 56  
 Accessories . . . . . 57  
**SL-156 Crimp Connectors and Headers** . . . . . 58-62  
 Wire-to-Board Mateability Guide . . . . . 58  
 Wire-to-Board Crimp Contacts and Keying Plugs . . . . . 59  
 Wire-to-Board Housings — UL94V-0 . . . . . 60  
 Housings with Through Board Latch — UL94V-2 . . . . . 61  
 Housings and Contacts for Large Insulation Diameter (LID) Wire . . . . . 62  
**AMP Economy Power (EP) Connector System** . . . . . 63-69  
   **.156 [3.96] Centerline Connectors**  
     Introduction . . . . . 63  
     Crimp Contacts . . . . . 64  
     Plug Housings, Low-Profile . . . . . 64  
     Low-Profile Headers — Straight and Right-Angle Posts . . . . . 65  
     Low-Profile Headers, High Temp. — Straight and Right-Angle Posts . . . . . 66  
   **.200 [5.08] Centerline Connectors**  
     Plug Housings and Straight and Right-Angle Post Headers . . . . . 67  
   **.312 [7.92] Centerline Connectors**  
     Low-Profile Headers — Straight Posts . . . . . 68  
**Single Connectors**  
   1-Position Plug Housing and High-Profile Header — Straight Post . . . . . 69  
**MTA Wire Selection and Ribbon Cable Preparation** . . . . . 70  
**IDC Ribbon Cable** . . . . . 71-74  
**MTA Wire Termination Flowchart** . . . . . 75  
**MTA Application Tooling** . . . . . 76-79  
**Part Number Index** . . . . . 80-82  
**Global Contacts** . . . . . 83

**Connector Selection Guide**

Product Name	Centerline	Contact Termination	Wire-to-Wire Option	No. of Positions	Wire Size (AWG)	Wire Insulation Dia. Max.	Current Rating (A)**	Voltage Rating Max. (VAC)	Operating Temp. Range (°C)	UL Flammability	Replacement Contacts	Approvals
<b>.050" Centerline</b>												
MTA-50 IDC Connector Kits and Headers	.050 1.27	IDC	Planned	2–28	30–26	.039* 0.99	1	30	–55 to +105	V-0 & V-2	No	
<b>.100" Centerline</b>												
MTA-100 Connectors and Headers	.100 2.54	IDC	Yes	2–28	28–22	.060* 1.52	5	250	–55 to +105	V-0 & V-2	Yes	
CST-100 II Contacts and Housings	.100 2.54	Crimp	Planned	2–28	26–22	.065 1.65	4	250	–55 to +105	V-0	Yes	
<b>.156" Centerline</b>												
MTA-156 Connectors and Headers	.156 3.96	IDC	Yes	2–24	26–18	.095* 2.41	7	600	–55 to +105	V-0 & V-2	Yes	
Quad Connectors	.156 3.96	IDC	No	2–12	22–18	.095* 2.41	12.5	600	–55 to +105	V-0	Yes	
SL-156 Contacts and Housings	.156 3.96	Crimp	No	1–24; 2–10 w/ through board latch	24–18	.105 2.67	10	250	–25 to +105	V-0	Yes	
SL-156 Large Ins. Dia. (LID) Contacts and Housings	.156 3.96	Crimp	No	2–24	24–16	.112 2.84	10	250	–25 to +105	V-0	Yes	
<b>.156", .200" and .312" Centerlines</b>												
AMP Economy Power (EP) Connector System	.156 3.96	Crimp	No	1–12	22–18	.118 3.00	8 (1 pos.) 7.5 (2–12 Pos.)	250	–25 to +105	V-0	Yes	
	.200 5.08	Crimp	No	2–12	22–18	.118 3.00	7.5 (2–12 Pos.)	250	–25 to +105	V-0	Yes	
	.312 7.92	Crimp	No	2–5	22–18	.118 3.00	7.5 (2–5 Pos.)	250	–25 to +105	V-0	Yes	

\* When terminated one position at a time.  
 \*\* Current Rating is application dependent.

**MTA-50 IDC Connectors and Headers**

**Product Facts**

- 2-28 contact positions
- Connectors terminate 26, 28 and 30 AWG discrete wire or .050 [1.27] centerline ribbon cable
- Color-coded housings
- Maximum cable insulation diameter of .039 [0.99] with PVC insulation only
- IDC contacts pre-loaded in receptacle housing
- 30 V, 1 A contact rating
- Contact design allows for gold-to-gold or tin-to-tin interface
- Contacts are lubricated to prevent fretting corrosion
- Wire feed-thru capability for daisy-chain wiring or closed end for point-to-point wiring
- Connectors are polarized for proper mating
- Manual and semiautomatic application tooling
- Mating heights shown below:



- Component Recognized by Underwriters Laboratories Inc. to US and Canadian Standards, File No. E28476 C **UL** US (Connectors and Headers) File No. E53793 (Ribbon Cable)

These matrices have been prepared to assist you in defining the correct mating halves for the MTA-50 header and connector kit combination. Where a "Y" is indicated the combination is a valid mating pair.

**Note:** Tyco Electronics does NOT recommend intermating connectors and headers with different contact platings.



The MTA-50 IDC Connector System is a wire-to-printed circuit board system with contacts in a staggered, single row on .050 [1.27] centerline. The design features wire feed-through capability for daisy-chain applications. Insulation displacement contacts are used to terminate a wide range of conductor sizes. Ribbon cable can also be terminated when the appropriate receptacle assembly and strain relief cover are used.

Header assemblies for board mount applications include right-angle (horizontal) and vertical mount products. These are available in

through-hole and surface mount configurations.

Typical uses of the MTA-50 IDC connectors would be in the Appliance, Commercial and Home Equipment and Security products industries.

See the following pages for related products:

- Ribbon Cable (reels), .050 [1.27] centerline (p. 71)
- Application Tooling (p. 76)
- Cable Assemblies (p. 74)

**Performance Data**

- Voltage Rating** — 30 VAC
- Current Rating** — 1 amp max.
- Low-Level Resistance** — 30 milliohms

**Dielectric Withstanding Voltage** — 500 VAC

**Insulation Resistance** — 1,000 megohms

**Operating Temperature** — -55°C to +105°C for connector only; cable rating may be lower

**Technical Documents**

**Application Specification** — 114-13072 MTA-50 Connectors

**Product Specifications** — 108-2113 MTA-50 Connectors

100-4703 MADISON CABLE Cable Specification (28 AWG, 7/36 Tinned copper, PVC insulation)

100-6257 MADISON CABLE Cable Specification (28 AWG, 7/36 Tinned copper, TPO insulation)

**MTA-50 IDC Connector Kit / Header Mateability Guide**

Connector Kits	Headers			
	1445120	1445121	1445169	1445172
1445341	Y	Y	Y	Y
1445344	Y	Y	Y	Y
1445347	Y	Y	Y	Y
1445350	Y	Y	Y	Y
1445353	Y	Y	Y	Y
1445356	Y	Y	Y	Y
1445359	Y	Y	Y	Y
1445362	Y	Y	Y	Y
1445365	Y	Y	Y	Y
1445368	Y	Y	Y	Y
1445371	Y	Y	Y	Y
1445374	Y	Y	Y	Y

**Matrix for Tin Plated Part Numbers**

Connector Kits	Headers			
	1445125	1445126	1445171	1445174
1445343	Y	Y	Y	Y
1445346	Y	Y	Y	Y
1445349	Y	Y	Y	Y
1445352	Y	Y	Y	Y
1445355	Y	Y	Y	Y
1445358	Y	Y	Y	Y
1445361	Y	Y	Y	Y
1445364	Y	Y	Y	Y
1445367	Y	Y	Y	Y
1445370	Y	Y	Y	Y
1445373	Y	Y	Y	Y
1445376	Y	Y	Y	Y

**Matrix for .00030 [0.00076] Gold Plated Part Numbers**

Connector Kits	Headers			
	1445123	1445124	1445170	1445173
1445342	Y	Y	Y	Y
1445345	Y	Y	Y	Y
1445348	Y	Y	Y	Y
1445351	Y	Y	Y	Y
1445354	Y	Y	Y	Y
1445357	Y	Y	Y	Y
1445360	Y	Y	Y	Y
1445363	Y	Y	Y	Y
1445366	Y	Y	Y	Y
1445369	Y	Y	Y	Y
1445372	Y	Y	Y	Y
1445375	Y	Y	Y	Y

**Matrix for .00015 [0.00038] Gold Plated Part Numbers**

**MTA-50 IDC Connectors and Headers (Continued)**

**Feed-Thru and Closed End Connectors**



**Material and Finish**

**Housing** — UL 94V-2 rated, thermo-plastic

**Contacts** — Phosphor bronze; .000100 [0.00254] min. tin in wire termination area, over .000050 [0.00127] min. nickel; choice on mating end: .000100 [0.00254] min. tin or .000030 [0.00076] gold or .000015 [0.00038] gold, over .000050 [0.00127] min. nickel

**Color Coding by Wire Size for UL94V-0 Connectors**

- 26 AWG** — Blue
- 28 AWG** — Green
- 30 AWG** — Brown

For Strain Relief Covers see page 6.  
For mating Headers see pages 9 and 10.  
For Mateability Guide, see matrixes on page 4.

**Receptacle Assemblies — Ribbon Cable**

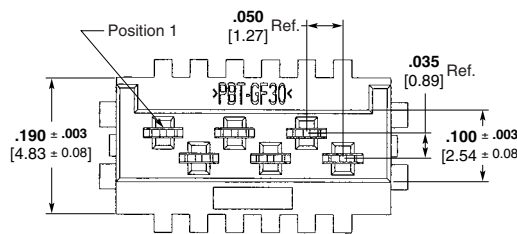
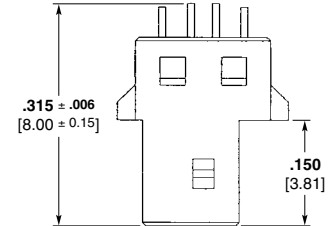
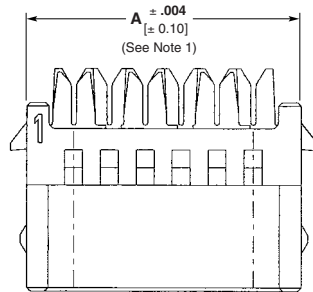

**Notes:**

1. To determine connector overall length (dim. A), multiply .050 x the number of circuits and add .082. Example: .050 x 10 circuits equals 0.50 + .082 = .582 [14.78].
2. Strain relief covers shown on page 6 are required and sold as part of the Connector Kit.
3. Stranded UL Style 1061 or equivalent wire is recommended.
4. Unless otherwise stated all tolerances (except plating) to be ±.005 [±0.13].
5. Consult Product Drawing for RoHS Compliant information.

**Connector Kits — Ribbon Cable**

**Connector Kit Ordering Information**

Connector Kit consists of Receptacle Assembly and Strain Relief Cover.

Base part number prefixes and suffixes indicate the number of circuit positions, for example: Base part number 1445359

2 position = 0-1445359-2  
and  
28 position = 2-1445359-8

**Note:** Tin-plated connectors and headers in even position sizes from 2–12 and 18 are stocked parts; all other position sizes and products with gold-plated contacts are Make To Order.

**Base Part Numbers**

Connector Type & Wire Size	Feed-Thru		Closed End	
	Connector Kit Part Nos.	No. of Circuits	Connector Kit Part Nos.	No. of Circuits
<b>Tin Plated</b>				
<b>26 AWG</b> 0.12–0.15 mm <sup>2</sup>	1445359	2–28	1445368	2–28
<b>28 AWG</b> 0.08–0.09 mm <sup>2</sup>	1445362	2–28	1445371	2–28
<b>30 AWG</b> 0.05–0.06 mm <sup>2</sup>	1445365	2–28	1445374	2–28
<b>.000030 [0.00076] Gold Plated</b>				
<b>26 AWG</b> 0.12–0.15 mm <sup>2</sup>	1445361	2–28	1445370	2–28
<b>28 AWG</b> 0.08–0.09 mm <sup>2</sup>	1445364	2–28	1445373	2–28
<b>30 AWG</b> 0.05–0.06 mm <sup>2</sup>	1445367	2–28	1445376	2–28
<b>.000015 [0.00038] Gold Plated</b>				
<b>26 AWG</b> 0.12–0.15 mm <sup>2</sup>	1445360	2–28	1445369	2–28
<b>28 AWG</b> 0.08–0.09 mm <sup>2</sup>	1445363	2–28	1445372	2–28
<b>30 AWG</b> 0.05–0.06 mm <sup>2</sup>	1445366	2–28	1445375	2–28



**MTA-50 IDC Connectors and Headers (Continued)**

**Connector Kits — Ribbon Cable (Continued)**

**Strain Relief Covers**

**Material and Finish**  
**Strain Relief Cover** — UL 94V-0 rated, thermoplastic, black



MTA-50  
.050 [1.27]

**Feed-Thru**



Feed-Thru

**Closed End**



Closed End

**Feed-Thru and Closed End**

No. of Circuits	Dim. A	No. of Circuits	Dim. A
2	.260 6.60	16	.960 24.38
3	.310 7.87	17	1.010 25.65
4	.360 9.14	18	1.060 26.92
5	.410 10.41	19	1.110 28.19
6	.460 11.68	20	1.160 29.46
7	.510 12.95	21	1.210 30.73
8	.560 14.22	22	1.260 32.00
9	.610 15.49	23	1.310 33.27
10	.660 16.76	24	1.360 34.54
11	.710 18.03	25	1.410 35.81
12	.760 19.30	26	1.460 37.08
13	.810 20.57	27	1.510 38.35
14	.860 21.84	28	1.560 39.62
15	.910 23.11		

**MTA-50 IDC Connectors and Headers (Continued)**

MTA-50  
.050 [1.27]

**Feed-Thru and Closed End Connectors**



**Receptacle Assemblies — Discrete Wire**



**Material and Finish**

**Housing** — UL 94V-2 rated, thermo-plastic

**Contacts** — Phosphor bronze; .000100 [0.00254] min. tin in wire termination area, over .000050 [0.00127] min. nickel; choice on mating end: .000100 [0.00254] min. tin or .000030 [0.00076] gold or .000015 [0.00038] gold, over .000050 [0.00127] min. nickel

**Color Coding by Wire Size for UL94V-0 Connectors**

- 26 AWG — Blue
- 28 AWG — Green
- 30 AWG — Brown

For Strain Relief Covers see page 8.  
For mating Headers see pages 9 and 10.  
For Mateability Guide, see matrixes on page 4.



**Notes:**

1. To determine connector overall length (dim. A), multiply .050 x the number of circuits and add .082. Example: .050 x 10 circuits equals 0.50 + .082 = .582 [14.78].
2. Strain relief covers shown on page 8 are required and sold as part of the Connector Kit.
3. Stranded UL Style 1061 or equivalent wire is recommended.
4. Unless otherwise stated all tolerances (except plating) to be ±.005 [±0.13].
5. Consult Product Drawing for RoHS Compliant information.

**Connector Kits — Discrete Wire**

**Connector Kit Ordering Information**

Connector Kit consists of Receptacle Assembly and Strain Relief Cover.

Base part number prefixes and suffixes indicate the number of circuit positions, for example: Base part number 1445341

- 2 position = 0-1445341-2 and
- 28 position = 2-1445341-8

**Note:** Tin-plated connectors and headers in even position sizes from 2–12 and 18 are stocked parts; all other position sizes and products with gold-plated contacts are Make To Order.

**Base Part Numbers**

Connector Type & Wire Size	Feed-Thru		Closed End	
	Connector Kit Part Nos.	No. of Circuits	Connector Kit Part Nos.	No. of Circuits
<b>Tin Plated</b>				
26 AWG 0.12–0.15 mm <sup>2</sup>	1445341	2–28	1445350	2–28
28 AWG 0.08–0.09 mm <sup>2</sup>	1445344	2–28	1445353	2–28
30 AWG 0.05–0.06 mm <sup>2</sup>	1445347	2–28	1445356	2–28
<b>.000030 [0.00076] Gold Plated</b>				
26 AWG 0.12–0.15 mm <sup>2</sup>	1445343	2–28	1445352	2–28
28 AWG 0.08–0.09 mm <sup>2</sup>	1445346	2–28	1445355	2–28
30 AWG 0.05–0.06 mm <sup>2</sup>	1445349	2–28	1445358	2–28
<b>.000015 [0.00038] Gold Plated</b>				
26 AWG 0.12–0.15 mm <sup>2</sup>	1445342	2–28	1445351	2–28
28 AWG 0.08–0.09 mm <sup>2</sup>	1445345	2–28	1445354	2–28
30 AWG 0.05–0.06 mm <sup>2</sup>	1445348	2–28	1445357	2–28



**MTA-50 IDC Connectors and Headers (Continued)**

**Connector Kits —  
Discrete Wire (Continued)**

**Strain Relief Covers**

**Material and Finish**  
**Strain Relief Cover** — UL 94V-0  
rated, thermoplastic, black

**Feed-Thru**



**Closed End**



**Feed-Thru**



**Closed End**

**Feed-Thru and Closed End**

No. of Circuits	Dim. A	No. of Circuits	Dim. A
2	.260 6.60	16	.960 24.38
3	.310 7.87	17	1.010 25.65
4	.360 9.14	18	1.060 26.92
5	.410 10.41	19	1.110 28.19
6	.460 11.68	20	1.160 29.46
7	.510 12.95	21	1.210 30.73
8	.560 14.22	22	1.260 32.00
9	.610 15.49	23	1.310 33.27
10	.660 16.76	24	1.360 34.54
11	.710 18.03	25	1.410 35.81
12	.760 19.30	26	1.460 37.08
13	.810 20.57	27	1.510 38.35
14	.860 21.84	28	1.560 39.62
15	.910 23.11		

MTA-50  
.050 [1.27]



## MTA-50 IDC Connectors and Headers (Continued)

### Through-Hole Header Assemblies

#### Vertical



#### Material and Finish

**Housing** — UL 94V-0 rated, thermo-plastic, black

**Contacts** — Brass, .000100 [0.00254] min. tin over .000050 [0.00127] min. nickel on solder legs; choice on mating end:  
.000100 [0.00254] min. tin or  
.000030 [0.00076] gold or  
.000015 [0.00038] gold, over  
.000050 [0.00127] min. nickel



**Note:** To determine header overall length (dim. A), multiply .050 x the number of circuits and add .150. Example: .050 x 6 circuits equals .300 + .150 = .450 [11.43].



**Recommended Mounting Hole Size and Pattern for .062 [1.57] Thick PC Board**

\* 6-circuit Dim. shown, refer to Product Drawing for actual PCB Dimensions and RoHS Compliant information.

#### Base Part Numbers

Through-Hole	
Header Part Nos.	No. of Posts
<b>Standard UL 94V-0, Tin Plated</b>	
1445120	2-28
<b>Standard UL 94V-0 .000030 [0.00076] Gold Plated</b>	
1445125	2-28
<b>Standard UL 94V-0 .000015 [0.00038] Gold Plated</b>	
1445123	2-28

#### Right-Angle



For mating Connector Kits see pages 5 through 8.

For mateability options, see matrixes on page 4.

#### Header Ordering Information

Base part number prefixes and suffixes indicate the number of circuit positions, for example: Base part number 1445120

2 position = 0-1445120-2  
and  
28 position = 2-1445120-8

**Note:** Tin-plated connectors and headers in even position sizes from 2-12 and 18 are stocked parts; all other position sizes and products with gold-plated contacts are Make To Order.



**Recommended Mounting Hole Size and Pattern for .062 [1.57] Thick PC Board**

\* 6-circuit Dim. shown, refer to Product Drawing for actual PCB Dimensions and RoHS Compliant information.

#### Base Part Numbers

Through-Hole	
Header Part Nos.	No. of Posts
<b>Standard UL 94V-0, Tin Plated</b>	
1445169	2-28
<b>Standard UL 94V-0 .000030 [0.00076] Gold Plated</b>	
1445171	2-28
<b>Standard UL 94V-0 .000015 [0.00038] Gold Plated</b>	
1445170	2-28

**MTA-50 IDC Connectors and Headers (Continued)**

**Surface Mount Header Assemblies**

**Vertical**



**Material and Finish**

**Housing** — UL 94V-0 rated, thermo-plastic, black

**Contacts** — Brass, .000100 [0.00254] min. tin over .000050 [0.00127] min. nickel on solder pads; choice on mating end:

.000100 [0.00254] min. tin or  
.000030 [0.00076] gold or  
.000015 [0.00038] gold, over  
.000050 [0.00127] min. nickel

**Boardlock** — Phosphor bronze, tin plated .000100 [0.000254] min. over .000050 [0.00127] min. nickel



**Note:** To determine header overall length (dim. A), multiply .050 x the number of circuits and add .150. Example: .050 x 6 circuits equals .300 + .150 = .450 [11.43].



**Recommended PC Board Layout**  
for use with .010 [0.25] Thick Stencil

\* 6-circuit Dim. shown, refer to Product Drawing for actual PCB Dimensions and RoHS Compliant information.

**Base Part Numbers**

Surface Mount	
Header Part Nos.	No. of Posts
<b>Standard UL 94V-0, Tin Plated</b>	
1445121	2-28
<b>Standard UL 94V-0 .000030 [0.00076] Gold Plated</b>	
1445126	2-28
<b>Standard UL 94V-0 .000015 [0.00038] Gold Plated</b>	
1445124	2-28

**Note:** All SMT product is pre-packaged in standard tape and reel format.

**Right-Angle**



For mating Connector Kits see pages 5 through 8.

For mateability options, see matrixes on page 4.



**Recommended PC Board Layout**  
for use with .010 [0.25] Thick Stencil

\* 6-circuit Dim. shown, refer to Product Drawing for actual PCB Dimensions and RoHS Compliant information.

**Base Part Numbers**

Surface Mount	
Header Part Nos.	No. of Posts
<b>Standard UL 94V-0, Tin Plated</b>	
1445172	2-28
<b>Standard UL 94V-0 .000030 [0.00076] Gold Plated</b>	
1445174	2-28
<b>Standard UL 94V-0 .000015 [0.00038] Gold Plated</b>	
1445173	2-28

**Header Ordering Information**

Base part number prefixes and suffixes indicate the number of circuit positions, for example: Base part number 1445121

2 position = 0-1445121-2  
and  
28 position = 2-1445121-8

**Note:** Tin-plated connectors and headers in even position sizes from 2-12 and 18 are stocked parts; all other position sizes and products with gold-plated contacts are Make To Order.

MTA-50  
.050 [1.27]

## .100 [2.54] Centerline MTA-100 IDC Connectors and Headers

### Product Facts

- Connectors and headers for 2 through 28 positions; wire sizes of 22, 24, 26 and 28 AWG [0.4-0.08 mm<sup>2</sup>]
- Wire-to-Post Connectors preloaded with dual beam contacts
- Connectors and headers, except shrouded headers, are end-to-end stackable
- Connector styles include both closed end and feed-thru connectors with locking ramps, with and without polarizing tabs
- Molded ribs on housing do not allow reverse mating
- Posted connectors for 2 through 19 positions
- Connectors preloaded with IDC contacts
- All contacts are slotted for insulation displacement (IDC) terminal technique
- Contacts are lubricated for fretting corrosion protection
- Benefits derived from the MTA-100 system include increased quality and ease of handling such as —
  - One-step assembly
  - No wire stripping
  - No contact damage
  - Reduced wiring errors
  - Simpler tooling
  - Simple maintenance and repair
- Meets the material requirements of Table 23.1 of UL1410 Standards for Television Receiver and Video Products (wire-to-post connectors only)
- Recognized under the Component Program of Underwriters Laboratories Inc., File No. E28476 
- Certified by Canadian Standards Association, File No. LR7189 

### Technical Documents

#### Product Specification

108-1050 MTA-100 Connectors

#### Application Specifications

114-1019 MTA-100 Connectors

114-1031 MTA-100 Ribbon Cable Assembly



MTA-100  
.100 [2.54]

MTA-100 connectors accept discrete and ribbon cable wire sizes ranging from 22–28 AWG [0.4–0.08 mm<sup>2</sup>] with maximum insulation outside diameter of .060 [1.52] for terminating single wire and .050 [1.27] for mass termination of wires. Tin plated solid, fused stranded, or stranded (7 strands) wire with PVC insulation can be used on 22–28 AWG [0.4–0.9 mm<sup>2</sup>] MTA-100 connectors and 19 stranded wire on 22–24 AWG [0.4–0.2 mm<sup>2</sup>] MTA-100 connectors. Only

one wire to be terminated into an IDC contact slot.

The wire-to-post connector housing material is flame retardant thermoplastic, either UL94V-2 or UL94V-0 rated.

A full line of .100 [2.54] centerline headers completes the system. Headers are available with straight or right-angle posts, in flat, polarized or friction lock styles. Headers are available in 2 through 28 positions. Shrouded headers are available in 2 through 14 positions.

### Performance Data\*

**Voltage Rating** — 250 vac

**Current Rating** — 5 amp max.

**Low-Level Resistance** — 6 mΩ max. initial

**Dielectric Withstanding Voltage** — 750 vac/1 min.

**Insulation Resistance** — 5000 MΩ min. initial

**Operating Temperature** — –55° C to +105° C

**Note:** Refer to page 70 for approved wire listings.

\*Refer to the Product Specification for additional electrical, mechanical and environmental performance tests and requirements.

### MTA-100 Connector/Header Mateability Guide

This matrix has been prepared to assist you, our customer, in defining the correct mating halves for the MTA-100 header and connector combination. Where a "Y" is indicated the combination is a valid mating pair. Where an "N" is indicated the combination is not acceptable for mating.

**Matrix for Tin Plated  
Part Numbers**

**Headers**

MTA-100  
.100 [2.54]

**Connectors**

	640452	640453	640454	640455	640456	640457	644456	644457	644486	644488	644694	644695	644803	644861	644874	644875	644876	644877	644892	644893	644894	647047	647048	647050	647051	647106	647166	647502	647531	647609	647623	647532	1744075
640440	Y	Y	Y	Y	Y	Y	Y	Y	Y	Y	Y	Y	Y	Y	Y	Y	Y	N	N	N	Y	Y	Y	Y	Y	Y	Y	Y	Y	Y	Y	Y	
640441	Y	Y	Y	Y	Y	Y	Y	Y	Y	Y	Y	Y	Y	Y	Y	Y	Y	N	N	N	Y	Y	Y	Y	Y	Y	Y	Y	Y	Y	Y	Y	
640442	Y	Y	Y	Y	Y	Y	Y	Y	Y	Y	Y	Y	Y	Y	Y	Y	Y	N	N	N	Y	Y	Y	Y	Y	Y	Y	Y	Y	Y	Y	Y	
640443	Y	Y	Y	Y	Y	Y	Y	Y	Y	Y	Y	Y	Y	Y	Y	Y	Y	N	N	N	Y	Y	Y	Y	Y	Y	Y	Y	Y	Y	Y	Y	
640468	Y	Y	Y	Y	Y	Y	Y	Y	Y	Y	Y	Y	Y	Y	Y	Y	Y	N	N	N	Y	Y	Y	Y	Y	Y	Y	Y	Y	Y	Y	Y	
640469	Y	Y	Y	Y	Y	Y	Y	Y	Y	Y	Y	Y	Y	Y	Y	Y	Y	N	N	N	Y	Y	Y	Y	Y	Y	Y	Y	Y	Y	Y	Y	
640470	Y	Y	Y	Y	Y	Y	Y	Y	Y	Y	Y	Y	Y	Y	Y	Y	Y	N	N	N	Y	Y	Y	Y	Y	Y	Y	Y	Y	Y	Y	Y	
640471	Y	Y	Y	Y	Y	Y	Y	Y	Y	Y	Y	Y	Y	Y	Y	Y	Y	N	N	N	Y	Y	Y	Y	Y	Y	Y	Y	Y	Y	Y	Y	
640620	Y	Y	Y	Y	Y	Y	Y	Y	Y	Y	Y	Y	Y	Y	Y	Y	Y	N	N	N	Y	Y	Y	Y	Y	Y	Y	Y	Y	Y	Y	Y	
640621	Y	Y	Y	Y	Y	Y	Y	Y	Y	Y	Y	Y	Y	Y	Y	Y	Y	N	N	N	Y	Y	Y	Y	Y	Y	Y	Y	Y	Y	Y	Y	
640622	Y	Y	Y	Y	Y	Y	Y	Y	Y	Y	Y	Y	Y	Y	Y	Y	Y	N	N	N	Y	Y	Y	Y	Y	Y	Y	Y	Y	Y	Y	Y	
640623	Y	Y	Y	Y	Y	Y	Y	Y	Y	Y	Y	Y	Y	Y	Y	Y	Y	N	N	N	Y	Y	Y	Y	Y	Y	Y	Y	Y	Y	Y	Y	
641311	Y	Y	Y	Y	Y	Y	Y	Y	Y	Y	Y	Y	Y	Y	Y	Y	Y	N	N	N	Y	Y	Y	Y	Y	Y	Y	Y	Y	Y	Y	Y	
641312	Y	Y	Y	Y	Y	Y	Y	Y	Y	Y	Y	Y	Y	Y	Y	Y	Y	N	N	N	Y	Y	Y	Y	Y	Y	Y	Y	Y	Y	Y	Y	
641313	Y	Y	Y	Y	Y	Y	Y	Y	Y	Y	Y	Y	Y	Y	Y	Y	Y	N	N	N	Y	Y	Y	Y	Y	Y	Y	Y	Y	Y	Y	Y	
641314	Y	Y	Y	Y	Y	Y	Y	Y	Y	Y	Y	Y	Y	Y	Y	Y	Y	N	N	N	Y	Y	Y	Y	Y	Y	Y	Y	Y	Y	Y	Y	
641534	Y	Y	Y	Y	Y	Y	Y	Y	Y	Y	Y	Y	Y	Y	Y	Y	Y	N	N	N	Y	Y	Y	Y	Y	Y	Y	Y	Y	Y	Y	Y	
641535	Y	Y	Y	Y	Y	Y	Y	Y	Y	Y	Y	Y	Y	Y	Y	Y	Y	N	N	N	Y	Y	Y	Y	Y	Y	Y	Y	Y	Y	Y	Y	
641536	Y	Y	Y	Y	Y	Y	Y	Y	Y	Y	Y	Y	Y	Y	Y	Y	Y	N	N	N	Y	Y	Y	Y	Y	Y	Y	Y	Y	Y	Y	Y	
641537	Y	Y	Y	Y	Y	Y	Y	Y	Y	Y	Y	Y	Y	Y	Y	Y	Y	N	N	N	Y	Y	Y	Y	Y	Y	Y	Y	Y	Y	Y	Y	
641653	Y	Y	Y	Y	Y	Y	Y	Y	Y	Y	Y	Y	Y	Y	Y	Y	Y	N	N	N	Y	Y	Y	Y	Y	Y	Y	Y	Y	Y	Y	Y	
641654	Y	Y	Y	Y	Y	Y	Y	Y	Y	Y	Y	Y	Y	Y	Y	Y	Y	N	N	N	Y	Y	Y	Y	Y	Y	Y	Y	Y	Y	Y	Y	
641655	Y	Y	Y	Y	Y	Y	Y	Y	Y	Y	Y	Y	Y	Y	Y	Y	Y	N	N	N	Y	Y	Y	Y	Y	Y	Y	Y	Y	Y	Y	Y	
641656	Y	Y	Y	Y	Y	Y	Y	Y	Y	Y	Y	Y	Y	Y	Y	Y	Y	N	N	N	Y	Y	Y	Y	Y	Y	Y	Y	Y	Y	Y	Y	
643498	Y	Y	Y	Y	Y	Y	Y	Y	Y	Y	Y	Y	Y	Y	Y	Y	Y	N	N	N	Y	Y	Y	Y	Y	Y	Y	Y	Y	Y	Y	Y	
643813	Y	Y	Y	Y	Y	Y	Y	Y	Y	Y	Y	Y	Y	Y	Y	Y	Y	N	N	N	Y	Y	Y	Y	Y	Y	Y	Y	Y	Y	Y	Y	
643814	Y	Y	Y	Y	Y	Y	Y	Y	Y	Y	Y	Y	Y	Y	Y	Y	Y	N	N	N	Y	Y	Y	Y	Y	Y	Y	Y	Y	Y	Y	Y	
643815	Y	Y	Y	Y	Y	Y	Y	Y	Y	Y	Y	Y	Y	Y	Y	Y	Y	N	N	N	Y	Y	Y	Y	Y	Y	Y	Y	Y	Y	Y	Y	
643816	Y	Y	Y	Y	Y	Y	Y	Y	Y	Y	Y	Y	Y	Y	Y	Y	Y	N	N	N	Y	Y	Y	Y	Y	Y	Y	Y	Y	Y	Y	Y	
643828	Y	Y	Y	Y	Y	Y	Y	Y	Y	Y	Y	Y	Y	Y	Y	Y	Y	N	N	N	Y	Y	Y	Y	Y	Y	Y	Y	Y	Y	Y	Y	
644083	Y	Y	Y	Y	Y	Y	Y	Y	Y	Y	Y	Y	Y	Y	Y	Y	Y	N	N	N	Y	Y	Y	Y	Y	Y	Y	Y	Y	Y	Y	Y	
644312	Y	Y	Y	Y	Y	Y	Y	Y	Y	Y	Y	Y	Y	Y	Y	Y	Y	N	N	N	Y	Y	Y	Y	Y	Y	Y	Y	Y	Y	Y	Y	
644313	Y	Y	Y	Y	Y	Y	Y	Y	Y	Y	Y	Y	Y	Y	Y	Y	Y	N	N	N	Y	Y	Y	Y	Y	Y	Y	Y	Y	Y	Y	Y	
644497	Y	Y	Y	Y	Y	Y	Y	Y	Y	Y	Y	Y	Y	Y	Y	Y	Y	N	N	N	Y	Y	Y	Y	Y	Y	Y	Y	Y	Y	Y	Y	
644511	Y	Y	Y	Y	Y	Y	Y	Y	Y	Y	Y	Y	Y	Y	Y	Y	Y	N	N	N	Y	Y	Y	Y	Y	Y	Y	Y	Y	Y	Y	Y	
644512	Y	Y	Y	Y	Y	Y	Y	Y	Y	Y	Y	Y	Y	Y	Y	Y	Y	N	N	N	Y	Y	Y	Y	Y	Y	Y	Y	Y	Y	Y	Y	
644513	Y	Y	Y	Y	Y	Y	Y	Y	Y	Y	Y	Y	Y	Y	Y	Y	Y	N	N	N	Y	Y	Y	Y	Y	Y	Y	Y	Y	Y	Y	Y	
644514	Y	Y	Y	Y	Y	Y	Y	Y	Y	Y	Y	Y	Y	Y	Y	Y	Y	N	N	N	Y	Y	Y	Y	Y	Y	Y	Y	Y	Y	Y	Y	
644540	Y	Y	Y	Y	Y	Y	Y	Y	Y	Y	Y	Y	Y	Y	Y	Y	Y	N	N	N	Y	Y	Y	Y	Y	Y	Y	Y	Y	Y	Y	Y	
644563	Y	Y	Y	Y	Y	Y	Y	Y	Y	Y	Y	Y	Y	Y	Y	Y	Y	N	N	N	Y	Y	Y	Y	Y	Y	Y	Y	Y	Y	Y	Y	
644564	Y	Y	Y	Y	Y	Y	Y	Y	Y	Y	Y	Y	Y	Y	Y	Y	Y	N	N	N	Y	Y	Y	Y	Y	Y	Y	Y	Y	Y	Y	Y	
644565	Y	Y	Y	Y	Y	Y	Y	Y	Y	Y	Y	Y	Y	Y	Y	Y	Y	N	N	N	Y	Y	Y	Y	Y	Y	Y	Y	Y	Y	Y	Y	
644574	Y	Y	Y	Y	Y	Y	Y	Y	Y	Y	Y	Y	Y	Y	Y	Y	Y	N	N	N	Y	Y	Y	Y	Y	Y	Y	Y	Y	Y	Y	Y	
644575	Y	Y	Y	Y	Y	Y	Y	Y	Y	Y	Y	Y	Y	Y	Y	Y	Y	N	N	N	Y	Y	Y	Y	Y	Y	Y	Y	Y	Y	Y	Y	
644576	Y	Y	Y	Y	Y	Y	Y	Y	Y	Y	Y	Y	Y	Y	Y	Y	Y	N	N	N	Y	Y	Y	Y	Y	Y	Y	Y	Y	Y	Y	Y	
644577	Y	Y	Y	Y	Y	Y	Y	Y	Y	Y	Y	Y	Y	Y	Y	Y	Y	N	N	N	Y	Y	Y	Y	Y	Y	Y	Y	Y	Y	Y	Y	
644578	Y	Y	Y	Y	Y	Y	Y	Y	Y	Y	Y	Y	Y	Y	Y	Y	Y	N	N	N	Y	Y	Y	Y	Y	Y	Y	Y	Y	Y	Y	Y	
644579	Y	Y	Y	Y	Y	Y	Y	Y	Y	Y	Y	Y	Y	Y	Y	Y	Y	N	N	N	Y	Y	Y	Y	Y	Y	Y	Y	Y	Y	Y	Y	
644795	Y	Y	Y	Y	Y	Y	Y	Y	Y	Y	Y	Y	Y	Y	Y	Y	Y	N	N	N	Y	Y	Y	Y	Y	Y	Y	Y	Y	Y	Y	Y	
*1375820	Y	Y	Y	Y	Y	Y	Y	N	N	Y	Y	N	N	Y	Y	Y	Y	Y	Y	Y	Y	Y	Y	Y	Y	Y	Y	Y	Y	Y	Y	Y	

\*Select contact plating to match header plating.

**MTA-100 Connector/Header Mateability Guide** (Continued)

This matrix has been prepared to assist you, our customer, in defining the correct mating halves for the MTA-100 header and connector combination. Where a “Y” is indicated the combination is a valid mating pair. Where an “N” is indicated the combination is not acceptable for mating.

**Matrix for .000030  
[0.00076] Gold Plated  
Part Numbers**

		Headers																									
		641211	641212	641213	641214	641215	641216	644487	644489	644884	644885	644886	644887	644896	644897	644898	647108	647109	647114	647116	647117	647168	647626	647624	647534	744047	744163
Connectors	641237	Y	Y	Y	Y	Y	Y	Y	Y	Y	Y	Y	Y	N	N	N	Y	Y	Y	Y	Y	Y	Y	Y	Y	Y	Y
	641238	Y	Y	Y	Y	Y	Y	Y	Y	Y	Y	Y	Y	N	N	N	Y	Y	Y	Y	Y	Y	Y	Y	Y	Y	Y
	641239	Y	Y	Y	Y	Y	Y	Y	Y	Y	Y	Y	Y	N	N	N	Y	Y	Y	Y	Y	Y	Y	Y	Y	Y	Y
	641240	Y	Y	Y	Y	Y	Y	Y	Y	Y	Y	Y	Y	N	N	N	Y	Y	Y	Y	Y	Y	Y	Y	Y	Y	Y
	641241	Y	Y	Y	Y	Y	Y	Y	Y	Y	Y	Y	Y	N	N	N	Y	Y	Y	Y	Y	Y	Y	Y	Y	Y	Y
	641242	Y	Y	Y	Y	Y	Y	Y	Y	Y	Y	Y	Y	N	N	N	Y	Y	Y	Y	Y	Y	Y	Y	Y	Y	Y
	641243	Y	Y	Y	Y	Y	Y	Y	Y	Y	Y	Y	Y	N	N	N	Y	Y	Y	Y	Y	Y	Y	Y	Y	Y	Y
	641244	Y	Y	Y	Y	Y	Y	Y	Y	Y	Y	Y	Y	N	N	N	Y	Y	Y	Y	Y	Y	Y	Y	Y	Y	Y
	644020	Y	Y	Y	Y	Y	Y	Y	Y	Y	Y	Y	Y	N	N	N	Y	Y	Y	Y	Y	Y	Y	Y	Y	Y	Y
	644042	Y	Y	Y	Y	Y	Y	Y	Y	Y	Y	Y	Y	N	N	N	Y	Y	Y	Y	Y	Y	Y	Y	Y	Y	Y
	644043	Y	Y	Y	Y	Y	Y	Y	Y	Y	Y	Y	Y	N	N	N	Y	Y	Y	Y	Y	Y	Y	Y	Y	Y	Y
	644044	Y	Y	Y	Y	Y	Y	Y	Y	Y	Y	Y	Y	N	N	N	Y	Y	Y	Y	Y	Y	Y	Y	Y	Y	Y
	644702	Y	Y	Y	Y	Y	Y	Y	Y	Y	Y	Y	Y	N	N	N	Y	Y	Y	Y	Y	Y	Y	Y	Y	Y	Y
	644726	Y	Y	Y	Y	Y	Y	Y	Y	Y	Y	Y	Y	N	N	N	Y	Y	Y	Y	Y	Y	Y	Y	Y	Y	Y
	*1375820	Y	Y	Y	Y	Y	Y	N	N	Y	Y	Y	Y	Y	Y	Y	Y	Y	Y	Y	Y	Y	Y	Y	Y	Y	Y

**Matrix for .000015  
[0.00038] Gold Plated  
Part Numbers**

		Headers																									
		641122	641123	641124	641125	641126	641127	644888	644889	644890	644891	647075	647076	647078	647079	647107	647167	647467	647625	647627	647533	1744074					
Connectors	641190	Y	Y	Y	Y	Y	Y	Y	Y	Y	Y	Y	Y	Y	Y	Y	Y	Y	Y	Y	Y	Y	Y	Y	Y	Y	
	641191	Y	Y	Y	Y	Y	Y	Y	Y	Y	Y	Y	Y	Y	Y	Y	Y	Y	Y	Y	Y	Y	Y	Y	Y	Y	
	641192	Y	Y	Y	Y	Y	Y	Y	Y	Y	Y	Y	Y	Y	Y	Y	Y	Y	Y	Y	Y	Y	Y	Y	Y	Y	
	641193	Y	Y	Y	Y	Y	Y	Y	Y	Y	Y	Y	Y	Y	Y	Y	Y	Y	Y	Y	Y	Y	Y	Y	Y	Y	
	641198	Y	Y	Y	Y	Y	Y	Y	Y	Y	Y	Y	Y	Y	Y	Y	Y	Y	Y	Y	Y	Y	Y	Y	Y	Y	
	641199	Y	Y	Y	Y	Y	Y	Y	Y	Y	Y	Y	Y	Y	Y	Y	Y	Y	Y	Y	Y	Y	Y	Y	Y	Y	
	641200	Y	Y	Y	Y	Y	Y	Y	Y	Y	Y	Y	Y	Y	Y	Y	Y	Y	Y	Y	Y	Y	Y	Y	Y	Y	
	641201	Y	Y	Y	Y	Y	Y	Y	Y	Y	Y	Y	Y	Y	Y	Y	Y	Y	Y	Y	Y	Y	Y	Y	Y	Y	
	644038	Y	Y	Y	Y	Y	Y	Y	Y	Y	Y	Y	Y	Y	Y	Y	Y	Y	Y	Y	Y	Y	Y	Y	Y	Y	
	644040	Y	Y	Y	Y	Y	Y	Y	Y	Y	Y	Y	Y	Y	Y	Y	Y	Y	Y	Y	Y	Y	Y	Y	Y	Y	
	647477	Y	Y	Y	Y	Y	Y	Y	Y	Y	Y	Y	Y	Y	Y	Y	Y	Y	Y	Y	Y	Y	Y	Y	Y	Y	
	647480	Y	Y	Y	Y	Y	Y	Y	Y	Y	Y	Y	Y	Y	Y	Y	Y	Y	Y	Y	Y	Y	Y	Y	Y	Y	
	*1375820	N	N	N	N	N	N	N	N	N	N	N	N	N	N	N	N	N	N	N	N	N	N	Y	Y	Y	Y
	1744020	Y	Y	Y	Y	Y	Y	Y	Y	Y	Y	Y	Y	Y	Y	Y	Y	Y	Y	Y	Y	Y	Y	Y	Y	Y	Y

\*Select contact plating to match header plating.

MTA-100  
.100 [2.54]

**MTA-100 IDC Connectors—Closed End and Feed-Thru**

**Material and Finish**

**Housing**—UL94V-2 rated, nylon, see below for color; or UL94V-0 rated, nylon, black

**Contacts**—Phosphor bronze, post tin plated, .000030 [0.00076] or .000015 [0.00038] post gold-plated over nickel

**Color Coding by Wire Size for UL94V-2 Connectors**

- 28 AWG—Green
- 26 AWG—Blue
- 24 AWG—White
- 22 AWG—Red

All wire sizes in UL94V-0—Black

For mateability options, see matrix on pages 12 and 13.

For mating half visuals, see pages 20 thru 30.

**Notes:**

1. Refer to pages 70-74 for approved wire listing.
2. For strain reliefs and dust covers, see page 16.
3. For keying plugs, see page 17.
4. Other circuit sizes are available upon request. Minimums may apply.
5. Connector circuits can be molded closed for keying purposes. Minimums may apply.
6. Where no part numbers appear in the chart, parts can be made available upon request. Minimums may apply.
7. To determine connector overall length (dim. A), multiply .100 x the number of circuits. Example: .100 x 10 circuits equals 1.000 inch [25.4 mm].

**Closed End Connectors**



Without Polarizing Tabs



With Polarizing Tabs

**Feed-Thru Connectors**



Without Polarizing Tabs



With Polarizing Tabs

MTA-100  
.100 [2.54]

## MTA-100 IDC Connectors—Closed End and Feed-Thru (Continued)

### Connector Ordering Information

The "Base Part Numbers" Chart at right shows the base part number, and their RoHS (Restrictions on Certain Hazardous Substances) Compliant (lead free) equivalent available for the described connectors.

Prefixes and suffixes are determined by the number of circuit positions in the connector. For example, the complete part number for a 10-position closed end connector without polarizing tabs for 22 AWG wire would be: Base number **640440** plus prefix-and-suffix **4- -0**

The correct ordering number is **4-640440-0**

All part numbers are the RoHS equivalent version. Example:

No. of Pos.	Lead Free RoHS Prefix/Suffix
2	3-640440-2
3	3-640440-3
4	3-640440-4
5	3-640440-5
6	3-640440-6
7	3-640440-7
8	3-640440-8
9	3-640440-9
10	4-640440-0
11	4-640440-1
12	4-640440-2
13	4-640440-3
14	4-640440-4
15	4-640440-5
16	4-640440-6
17	4-640440-7
18	4-640440-8
19	4-640440-9
20	5-640440-0
21	5-640440-1
22	5-640440-2
23	5-640440-3
24	5-640440-4
25	5-640440-5
26	5-640440-6
27	5-640440-7
28	5-640440-8

**Note:** All RoHS equivalent part numbers may not be available upon catalog release. If the number you need is not available, please contact Product Engineering to expedite your request.

### Base Part Numbers

Connector Type & Wire Size	Closed End				Feed-Thru			
	Without Tabs		With Tabs		Without Tabs		With Tabs	
	Connector Part Nos.	RoHS Equiv.	Connector Part Nos.	RoHS Equiv.	Connector Part Nos.	RoHS Equiv.	Connector Part Nos.	RoHS Equiv.
<b>Standard UL94V-2, Tin Plated</b>								
<b>22 AWG</b> 0.3–0.4 mm <sup>2</sup>	640440	<b>32–58</b>	643813	<b>32–58</b>	640620	<b>32–58</b>	644540 <sup>1</sup>	<b>32–45</b>
<b>24 AWG</b> 0.2 mm <sup>2</sup>	640441	<b>32–58</b>	643814	<b>32–58</b>	640621	<b>32–58</b>	644563 <sup>1</sup>	<b>32–54</b>
<b>26 AWG</b> 0.12–0.15 mm <sup>2</sup>	640442	<b>32–58</b>	643815	<b>32–58</b>	640622	<b>32–58</b>	644564 <sup>1</sup>	<b>32–45</b>
<b>28 AWG</b> 0.08–0.09 mm <sup>2</sup>	640443	<b>32–58</b>	643816	<b>32–58</b>	640623	<b>32–58</b>	644565 <sup>1</sup>	<b>32–45</b>
<b>Tape Mounted on Reel UL94V-2, Tin Plated</b>								
<b>22 AWG</b> 0.3–0.4 mm <sup>2</sup>	640468	<b>32–58</b>	644511	<b>42–68</b>	641311	<b>32–58</b>	—	—
<b>24 AWG</b> 0.2 mm <sup>2</sup>	640469	<b>32–58</b>	644512	<b>32–58</b>	641312	<b>32–58</b>	—	—
<b>26 AWG</b> 0.12–0.15 mm <sup>2</sup>	640470	<b>32–58</b>	644513	<b>32–58</b>	641313	<b>32–58</b>	—	—
<b>28 AWG</b> 0.08–0.09 mm <sup>2</sup>	640471	<b>32–58</b>	644514	<b>32–58</b>	641314	<b>32–58</b>	—	—
<b>Standard UL94V-2, .000030 [0.00076] Gold Plated</b>								
<b>22 AWG</b> 0.3–0.4 mm <sup>2</sup>	641237	<b>32–58</b>	644042	<b>32–58</b>	641241	<b>32–58</b>	644702 <sup>1</sup>	<b>32–45</b>
<b>24 AWG</b> 0.2 mm <sup>2</sup>	641238	<b>32–58</b>	644020	<b>32–58</b>	641242	<b>32–58</b>	—	—
<b>26 AWG</b> 0.12–0.15 mm <sup>2</sup>	641239	<b>32–58</b>	644043 <sup>1</sup>	<b>32–44</b>	641243	<b>32–58</b>	644726 <sup>1</sup>	<b>32–45</b>
<b>28 AWG</b> 0.8–0.9 mm <sup>2</sup>	641240	<b>32–58</b>	644044 <sup>1</sup>	<b>32–44</b>	641244	<b>32–58</b>	—	—
<b>Standard UL94V-2, .000015 [0.00038] Gold Plated</b>								
<b>22 AWG</b> 0.3–0.4 mm <sup>2</sup>	641190	<b>32–58</b>	644038 <sup>1</sup>	<b>32–44</b>	641198	<b>32–58</b>	647477	<b>32–46</b>
<b>24 AWG</b> 0.2 mm <sup>2</sup>	641191	<b>32–58</b>	1744020 <sup>1</sup>	<b>32–44</b>	641199	<b>32–58</b>	—	—
<b>26 AWG</b> 0.12–0.15 mm <sup>2</sup>	641192	<b>32–58</b>	644040 <sup>1</sup>	<b>32–44</b>	641200	<b>32–58</b>	647480	<b>32–43</b>
<b>28 AWG</b> 0.08–0.09 mm <sup>2</sup>	641193	<b>32–58</b>	—	—	641201	<b>32–58</b>	—	—
<b>LED*, UL94V-2, Tin Plated (See Note 1)</b>								
<b>22 AWG</b> 0.3–0.4 mm <sup>2</sup>	641534	<b>32–33</b>	—	—	641653	<b>32–33</b>	—	—
<b>24 AWG</b> 0.2 mm <sup>2</sup>	641535	<b>32–33</b>	644795	<b>32–33</b>	641654	<b>32–33</b>	—	—
<b>26 AWG</b> 0.12–0.15 mm <sup>2</sup>	641536	<b>32–33</b>	—	—	641655	<b>32–33</b>	—	—
<b>28 AWG</b> 0.08–0.09 mm <sup>2</sup>	641537	<b>32–33</b>	—	—	641656	<b>32–33</b>	—	—
<b>Standard UL94V-0, Tin Plated (Gold is available, minimums may apply.) (Black in color)</b>								
<b>22 AWG</b> 0.3–0.4 mm <sup>2</sup>	643498 <sup>1</sup>	<b>32–45</b>	644083 <sup>1</sup>	<b>32–45</b>	644575 <sup>1</sup>	<b>32–45</b>	644578 <sup>1</sup>	<b>32–45</b>
<b>24 AWG</b> 0.2 mm <sup>2</sup>	644574 <sup>1</sup>	<b>32–45</b>	644312 <sup>1</sup>	<b>32–45</b>	644576 <sup>1</sup>	<b>32–45</b>	644579 <sup>1</sup>	<b>32–45</b>
<b>26 AWG</b> 0.12–0.15 mm <sup>2</sup>	643828 <sup>1</sup>	<b>32–45</b>	644313 <sup>1</sup>	<b>32–45</b>	644577 <sup>1</sup>	<b>32–45</b>	644497 <sup>1</sup>	<b>32–45</b>

\*LED connectors are designed to mate with .014–.020 [0.36–0.51] diameter posts or square leads.

<sup>1</sup> Other circuit sizes are available upon request. Minimums may apply.

<sup>2</sup> Tape mounted.

**Note:** Blocked circuit configurations are available. Contact product engineer or product manager for details. Minimums may apply.

**MTA-100 IDC Connector Accessories**

**Covers**

**Material (RoHS Compliant)**

**Strain Relief Cover** — UL94V-2 rated, nylon, white

**Dust Covers** — UL94V-0 rated, polyester, white

**Closed End Strain Relief Covers**



**Closed End Dust Covers**



**Feed-Thru Strain Relief Covers**



**Feed-Thru Dust Covers**



**Cover Ordering Information**

The "Base Part Numbers" Chart at right shows the base part number and number of circuits available for the described cover.

Prefixes and suffixes are determined by the number of circuit positions in the cover. For example, the complete part number for a 10-position closed end strain relief cover would be:

Base number **643075** plus prefix-and-suffix

**1- -0**

The correct ordering number is

**1-643075-0**

**Base Part Numbers**

Closed End				Feed-Thru			
Strain Relief Covers		Dust Covers		Strain Relief Covers		Dust Covers	
Cover Part Nos.	No. of Circuits	Cover Part Nos.	No. of Circuits	Cover Part Nos.	No. of Circuits	Cover Part Nos.	No. of Circuits
643075	2-28	640550	2-28	643077	2-28	640642	3-28

**Cover Length**

No. of Circuits	Dim. A	Prefix/Suffix	No. of Circuits	Dim. A	Prefix/Suffix	No. of Circuits	Dim. A	Prefix/Suffix	No. of Circuits	Dim. A	Prefix/Suffix
2	.200 5.08	-2	9	.900 22.86	-9	16	1.600 40.64	1- -6	23	2.300 58.42	2- -3
3	.300 7.62	-3	10	1.00 25.4	1- -0	17	1.700 43.18	1- -7	24	2.400 60.96	2- -4
4	.400 10.16	-4	11	1.100 27.94	1- -1	18	1.800 45.72	1- -8	25	2.500 63.5	2- -5
5	.500 12.7	-5	12	1.200 30.48	1- -2	19	1.900 48.26	1- -9	26	2.600 66.04	2- -6
6	.600 15.24	-6	13	1.300 33.02	1- -3	20	2.000 50.8	2- -0	27	2.700 68.58	2- -7
7	.700 17.78	-7	14	1.400 35.56	1- -4	21	2.100 53.34	2- -1	28	2.800 71.12	2- -8
8	.800 20.32	-8	15	1.500 38.1	1- -5	22	2.200 55.88	2- -2			

MTA-100  
.100 [2.54]



**MTA-100 IDC Connector Accessories (Continued)**

**Keying Plug with Carrier Strip (10 plugs per strip)  
Part No. 641994-1**

**Material (RoHS Compliant)**  
UL94V-2 rated, nylon, natural color



**Note:** Removal of contact is not necessary when using keying plug.



**Replacement IDC Contacts**

**Material and Finish**

Phosphor bronze, post tin plated;  
.000030 [0.00076] or .000015 [0.00038] post gold plated over nickel

Wire Size		Part Numbers			
AWG	mm <sup>2</sup>	Standard Tin Plated	.000030 [0.00076] Gold Plated	.000015 [0.00038] Gold Plated	LED Tin Plated
22	0.3–0.4	640636-3	641186-4	641186-3	641643-2
24	0.2	640637-3	641187-4	641187-3	641644-2
26	0.12–0.15	640638-3	641188-4	641188-3	641645-2
28	0.08–0.09	640639-2	641189-4	641189-3	641646-2

**Note:** Tyco Electronics does not recommend terminating an MTA contact more than one time. Use replacement contacts when required for field repairs or wire changes.



**Crimp Snap-In Contacts**

**Material and Finish**

Phosphor bronze, tin plated



Wire Size		Part Nos.	
AWG	mm <sup>2</sup>	Loose Piece*	Strip**
26-22	0.12–0.4	640709-2	640708-2

\*\*Hand Tool No. 59836-1 (IS 408-6527)  
\*\*Applicator No. 466747-1 (IS 408-8040)

- Special applications for crimp snap-in contacts are:
1. Double wire per contact
  2. Coax or shielded wire
  3. Mixed wire size in same connector

**Note:** Only one crimp snap-in contact per connector.

## MTA-100 Posted Connector/Connector Mateability Guide

This matrix has been prepared to assist you, our customer, in defining the correct mating halves for the MTA-100 posted connector and connector combination. Where a "Y" is indicated the combination is a valid mating pair. Where an "N" is indicated the combination is not acceptable for mating.

### Matrix for Tin Plated Part Numbers

### Posted Connectors

	647000	647001	647002	647003	647004	647005	647006	647007
640440	Y	Y	Y	Y	Y	Y	Y	Y
640441	Y	Y	Y	Y	Y	Y	Y	Y
640442	Y	Y	Y	Y	Y	Y	Y	Y
640443	Y	Y	Y	Y	Y	Y	Y	Y
640468	Y	Y	Y	Y	Y	Y	Y	Y
640469	Y	Y	Y	Y	Y	Y	Y	Y
640470	Y	Y	Y	Y	Y	Y	Y	Y
640471	Y	Y	Y	Y	Y	Y	Y	Y
640620	Y	Y	Y	Y	Y	Y	Y	Y
640621	Y	Y	Y	Y	Y	Y	Y	Y
640622	Y	Y	Y	Y	Y	Y	Y	Y
640623	Y	Y	Y	Y	Y	Y	Y	Y
641311	Y	Y	Y	Y	Y	Y	Y	Y
641312	Y	Y	Y	Y	Y	Y	Y	Y
641313	Y	Y	Y	Y	Y	Y	Y	Y
641314	Y	Y	Y	Y	Y	Y	Y	Y
641534	Y	Y	Y	Y	Y	Y	Y	Y
641535	Y	Y	Y	Y	Y	Y	Y	Y
641536	Y	Y	Y	Y	Y	Y	Y	Y
641537	Y	Y	Y	Y	Y	Y	Y	Y
641653	Y	Y	Y	Y	Y	Y	Y	Y
641654	Y	Y	Y	Y	Y	Y	Y	Y
641655	Y	Y	Y	Y	Y	Y	Y	Y
641656	Y	Y	Y	Y	Y	Y	Y	Y
643498	Y	Y	Y	Y	Y	Y	Y	Y
643813	Y*	Y*	Y*	Y*	Y*	Y*	Y*	Y*
643814	Y*	Y*	Y*	Y*	Y*	Y*	Y*	Y*
643815	Y*	Y*	Y*	Y*	Y*	Y*	Y*	Y*
643816	Y*	Y*	Y*	Y*	Y*	Y*	Y*	Y*
643828	Y	Y	Y	Y	Y	Y	Y	Y
644083	Y*	Y*	Y*	Y*	Y*	Y*	Y*	Y*
644312	Y*	Y*	Y*	Y*	Y*	Y*	Y*	Y*
644313	Y*	Y*	Y*	Y*	Y*	Y*	Y*	Y*
644497	Y*	Y*	Y*	Y*	Y*	Y*	Y*	Y*
644511	Y*	Y*	Y*	Y*	Y*	Y*	Y*	Y*
644512	Y*	Y*	Y*	Y*	Y*	Y*	Y*	Y*
644513	Y*	Y*	Y*	Y*	Y*	Y*	Y*	Y*
644514	Y*	Y*	Y*	Y*	Y*	Y*	Y*	Y*
644540	Y*	Y*	Y*	Y*	Y*	Y*	Y*	Y*
644563	Y*	Y*	Y*	Y*	Y*	Y*	Y*	Y*
644564	Y*	Y*	Y*	Y*	Y*	Y*	Y*	Y*
644565	Y*	Y*	Y*	Y*	Y*	Y*	Y*	Y*
644574	Y	Y	Y	Y	Y	Y	Y	Y
644575	Y	Y	Y	Y	Y	Y	Y	Y
644576	Y	Y	Y	Y	Y	Y	Y	Y
644577	Y	Y	Y	Y	Y	Y	Y	Y
644578	Y*	Y*	Y*	Y*	Y*	Y*	Y*	Y*
644579	Y*	Y*	Y*	Y*	Y*	Y*	Y*	Y*
644795	Y*	Y*	Y*	Y*	Y*	Y*	Y*	Y*
1375820	N	N	N	N	N	N	N	N

\*2 & 3 position MTA-100 Posted Connectors can not mate with MTA-100 connectors with polarizing tabs.

MTA-100  
.100 [2.54]

Connectors

### MTA-100 Posted Connector/Connector Mateability Guide (Continued)

This matrix has been prepared to assist you, our customer, in defining the correct mating halves for the MTA-100 posted connector and connector combination. Where a "Y" is indicated the combination is a valid mating pair. Where an "N" is indicated the combination is not acceptable for mating.

Matrix for .000030  
[0.00076] Gold Plated  
Part Numbers

		Posted Connectors							
		647008	647009	647010	647011	647012	647013	647014	647015
Connectors	641237	Y	Y	Y	Y	Y	Y	Y	Y
	641238	Y	Y	Y	Y	Y	Y	Y	Y
	641239	Y	Y	Y	Y	Y	Y	Y	Y
	641240	Y	Y	Y	Y	Y	Y	Y	Y
	641241	Y	Y	Y	Y	Y	Y	Y	Y
	641242	Y	Y	Y	Y	Y	Y	Y	Y
	641243	Y	Y	Y	Y	Y	Y	Y	Y
	641244	Y	Y	Y	Y	Y	Y	Y	Y
	644020	Y*	Y*	Y*	Y*	Y*	Y*	Y*	Y*
	644042	Y*	Y*	Y*	Y*	Y*	Y*	Y*	Y*
	644043	Y*	Y*	Y*	Y*	Y*	Y*	Y*	Y*
	644044	Y*	Y*	Y*	Y*	Y*	Y*	Y*	Y*
	644702	Y*	Y*	Y*	Y*	Y*	Y*	Y*	Y*
	644726	Y*	Y*	Y*	Y*	Y*	Y*	Y*	Y*
	1375820	N	N	N	N	N	N	N	N

\*2 & 3 position MTA-100 Posted Connectors can not mate with MTA-100 connectors with polarizing tabs.

Matrix for .000015  
[0.00038] Gold Plated  
Part Numbers

		Posted Connectors							
		647008	647009	647010	647011	647012	647013	647014	647015
Connectors	641190	Y	Y	Y	Y	Y	Y	Y	Y
	641191	Y	Y	Y	Y	Y	Y	Y	Y
	641192	Y	Y	Y	Y	Y	Y	Y	Y
	641193	Y	Y	Y	Y	Y	Y	Y	Y
	641198	Y	Y	Y	Y	Y	Y	Y	Y
	641199	Y	Y	Y	Y	Y	Y	Y	Y
	641200	Y	Y	Y	Y	Y	Y	Y	Y
	641201	Y	Y	Y	Y	Y	Y	Y	Y
	644038	Y*	Y*	Y*	Y*	Y*	Y*	Y*	Y*
	644040	Y*	Y*	Y*	Y*	Y*	Y*	Y*	Y*
	647477	Y*	Y*	Y*	Y*	Y*	Y*	Y*	Y*
	647480	Y*	Y*	Y*	Y*	Y*	Y*	Y*	Y*
	1375820	N	N	N	N	N	N	N	N
	1744020	Y*	Y*	Y*	Y*	Y*	Y*	Y*	Y*

\*2 & 3 position MTA-100 Posted Connectors can not mate with MTA-100 connectors with polarizing tabs.

**MTA-100 IDC Posted Connectors (Wire-to-Wire)—Closed End, Feed-Thru**

**Material and Finish**

**Housing** — UL 94V-2 rated, nylon, see chart for color

**Contacts** — Copper alloy, post tin or gold plated over nickel (see chart)

**Notes:**

1. Mating half visuals - pages 14 & 15.
2. Use feed thru strain relief covers & feed thru dust covers (if needed) - page 16.
3. Approved wire listing - pages 70 thru 74.

MTA-100  
.100 [2.54]



**Closed End**

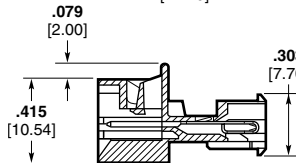

**Feed-Thru**

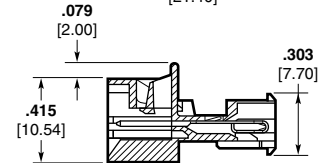

**Connector Ordering Information**

The "Base Part Numbers" Chart at right shows the base part number.

Prefixes and suffixes are determined by the number of circuit positions in the connector. For example, the complete part number for a 12-position closed end connector for 22 AWG wire would be:

Base number **647000** plus prefix-and-suffix **4-2**

The correct ordering number is **4-647000-2**

All part numbers are the RoHS equivalent version. Example:

No. of Pos.	Lead Free RoHS Prefix/Suffix
2	3-647000-2
	thru
19	4-647000-9

See page 15 for an explanation of RoHS lead free equivalents.

**Note:** All RoHS equivalent part numbers may not be available upon catalog release. If the number you need is not available, please contact Product Engineering to expedite your request.

**Color Coding by Wire Size for UL 94V-2 Connectors**

- 22 AWG — Red
- 24 AWG — White
- 26 AWG — Blue
- 28 AWG — Green

**Performance Data**

**Voltage Rating** — 250 VAC

**Current Rating** — 4 amp max.

**Low-Level Resistance** — 16 mΩ max. initial

**Dielectric Withstanding Voltage** — 750 VAC/1 min.

**Insulation Resistance** — 5000 MΩ min. initial

**Operating Temperature** —

**Base Part Numbers**

Connector Type & Wire Size	Closed End Connector		Feed-Thru Connector	
	Part Nos.	RoHS Equiv.	Part Nos.	No. of Circuits
<b>Standard UL 94V-2, Tin Plated</b>				
22 AWG 0.3–0.4 mm <sup>2</sup>	647000	32–49 <sup>1</sup>	647004	— <sup>2</sup>
24 AWG 0.2 mm <sup>2</sup>	647001	32–49 <sup>1</sup>	647005	— <sup>2</sup>
26 AWG 0.12–0.15 mm <sup>2</sup>	647002	32–49 <sup>1</sup>	647006	— <sup>2</sup>
28 AWG 0.08–0.09 mm <sup>2</sup>	647003	32–49 <sup>1</sup>	647007	— <sup>2</sup>
<b>Standard UL 94V-2, .000030 [0.00076] Gold Plated</b>				
22 AWG 0.3–0.4 mm <sup>2</sup>	647008	32–49 <sup>1</sup>	647012	— <sup>2</sup>
24 AWG 0.2 mm <sup>2</sup>	647009	32–49 <sup>1</sup>	647013	— <sup>2</sup>
26 AWG 0.12–0.15 mm <sup>2</sup>	647010	32–49 <sup>1</sup>	647014	— <sup>2</sup>
28 AWG 0.08–0.09 mm <sup>2</sup>	647011	32–49 <sup>1</sup>	647015	— <sup>2</sup>
<b>Standard UL 94V-2, .000015 [0.00038] Gold Plated</b>				
22 AWG 0.3–0.4 mm <sup>2</sup>	647016	32–49 <sup>1</sup>	647020	— <sup>2</sup>
24 AWG 0.2 mm <sup>2</sup>	647017	32–49 <sup>1</sup>	647021	— <sup>2</sup>
26 AWG 0.12–0.15 mm <sup>2</sup>	647018	32–49 <sup>1</sup>	647022	— <sup>2</sup>
28 AWG 0.08–0.09 mm <sup>2</sup>	647019	32–49 <sup>1</sup>	647023	— <sup>2</sup>

<sup>1</sup> 2 and 3 position MTA-100 Posted Connectors (Closed End) **can not mate** with MTA-100 connectors with polarizing tabs.  
<sup>2</sup> Parts may be manufactured upon request. Minimums may apply. Contact product engineer or product manager for details.

No. of Circuits	Dim.		No. of Circuits	Dim.		No. of Circuits	Dim.		No. of Circuits	Dim.	
	A	B		A	B		A	B		A	B
2	.300 [7.62]	.227 [5.77]	6	.700 [17.78]	.627 [15.93]	10	1.100 [27.94]	1.027 [26.09]	14	1.500 [38.10]	1.427 [36.25]
3	.400 [10.16]	.327 [8.31]	7	.800 [20.32]	.727 [18.47]	11	1.200 [30.48]	1.127 [28.63]	15	1.600 [40.64]	1.527 [38.79]
4	.500 [12.70]	.427 [10.85]	8	.900 [22.86]	.827 [21.01]	12	1.300 [33.02]	1.227 [31.17]	16	1.700 [43.18]	1.627 [41.33]
5	.600 [15.24]	.527 [13.39]	9	1.000 [25.40]	.927 [23.55]	13	1.400 [35.56]	1.327 [33.71]	17	1.800 [45.72]	1.727 [43.87]
									18	1.900 [48.26]	1.827 [46.41]
									19	2.000 [50.80]	1.927 [48.95]

–55°C to +105°C

**Technical Documents**

**Product Specification**  
108-1050-1 MTA-100 Posted Connector

**Application Specification**  
114-1019 MTA-100 Connectors

**Replacement IDC Contacts**

**Material and Finish**

**Contacts** — Copper alloy, post tin or gold plated over nickel



Wire Size AWG mm <sup>2</sup>	Part Numbers	
	Tin Plated	.000030 [0.00076] Gold Plated
22 0.3–0.4	3-647030-1	3-647030-2
24 0.2	3-647031-1	3-647031-2
26 0.12–0.15	3-647032-1	3-647032-2
28 0.8–0.9	3-647033-1	3-647033-2

## MTA-100 Flat Headers—Straight and Right-Angle

### Material and Finish

**Housing**—UL94V-0 rated, polyester, white

**Posts**—Copper alloy, tin plated, .000030 [0.00076] or .000015 [0.00038] gold over nickel

**Notes:**

1. Post(s) can be omitted for keying purposes. Specify the desired post(s) to be omitted using the figure to identify Post No. 1.
2. Gold headers are duplex plated, gold on mating end of post and tin on the solder tail.
3. To determine header overall length (dim. A) multiply .100 x the number of posts. Example: .100 x 10 posts equals 1.000 inch [25.4 mm].

For mateability options, see matrix on pages 12 and 13.

For mating half visuals, see pages 14, 15 and 31.

### Header Ordering Information

The “Base Part Numbers” Chart at right shows the base part number.

Prefixes and suffixes are determined by the number of post positions in the header. For example, the complete part number for a 10-position header with straight posts would be:

Base number **641211** plus prefix-and-suffix **4- — 0**

The correct ordering number is **4-641211-0**

All part numbers are the RoHS equivalent version. Example:

No. of Pos.	Lead Free RoHS Prefix/Suffix
2	3-641211-2
	thru
28	5-641211-8

See page 15 for an explanation of RoHS lead free equivalents.

**Note:** All RoHS equivalent part numbers may not be available upon catalog release. If the number you need is not available, please contact Product Engineering to expedite your request.

**Note:** Select load headers (omitted pin headers) are available upon request. Please contact product engineer or product manager for details.

### Straight Post (.025 [0.64] Square)



### Right-Angle Post (.025 [0.64] Square)



X = .120 [3.05] min., .240 [6.1] max.  
when mated with MTA-100 Connector.  
X = .120 [3.05] min., when mated with  
CST-100 II Connector.



Recommended Mounting Hole Pattern for  
.062 [1.57] Thk. PC Board



Recommended Mounting Hole Pattern for  
.062 [1.57] Thk. PC Board

**Note:** Consult Product Drawing for details on placing headers onto PC boards.

### Base Part Numbers

Straight Posts		Right-Angle Posts	
Header Part Nos.	No. of Posts/RoHS Equiv.	Header Part Nos.	No. of Posts/RoHS Equiv.
<b>Standard UL94V-0, Tin Plated</b>			
640452	2-28	640453	2-28
<b>Standard UL94V-0, .000030 [0.00076] Gold Plated</b>			
641211	2-28 32-58	641212	2-28 32-58
<b>Standard UL94V-0, .000015 [0.00038] Gold Plated</b>			
641122	2-28 32-58	641123	2-28 32-58

## MTA-100 Narrow Flat Headers—Straight and Right-Angle

### Material and Finish

**Housing** — UL94V-0 rated, polyester, white

**Posts** — Copper alloy, tin plated, .000030 [0.00076] or .000015 [0.00038] gold over nickel

**Notes:**

1. Post(s) can be omitted for keying purposes. Specify the desired post(s) to be omitted using the figure to identify Post No. 1.
2. Headers without retentive legs are suitable for breakaway application.
3. 2 or 3 retentive leg(s) per header, depending upon number of positions.
4. Gold headers are duplex plated, gold on mating end of post and tin on the solder tail.
5. To determine header overall length (dim. A) multiply .100 x the number of posts minus (-) .012. Example: .100 x 10 posts - .012 = .988 inches [25.1 mm].

For mateability options, see matrix on pages 12 and 13.

For mating half visuals, see pages 14, 15 and 31.

### Connector Ordering Information

The "Base Part Numbers" Chart at right shows the base part number.

Prefixes and suffixes are determined by the number of post positions in the header. For example, the complete part number for a 10-position header with straight posts and without retentive legs would be:

Base number **644456** plus prefix-and-suffix **4- -0**

The correct ordering number is **4-644456-0**

All part numbers are the RoHS equivalent version. Example:

No. of Pos.	Lead Free RoHS Prefix/Suffix
2	3-644456-2
thru	
28	5-644456-8

See page 15 for an explanation of RoHS lead free equivalents.

**Note:** All RoHS equivalent part numbers may not be available upon catalog release. If the number you need is not available, please contact Product Engineering to expedite your request.

**Note:**

Select load headers (omitted pin headers) are available upon request. Please contact product engineer or product manager for details.

### Straight Post (.025 [0.64] Square)



### Right-Angle Post (.025 [0.64] Square)

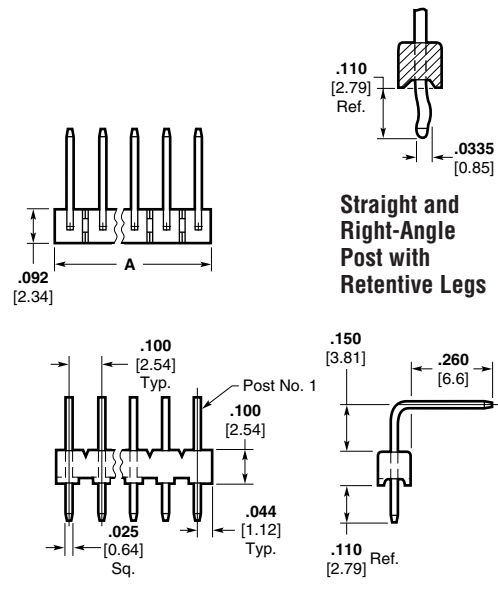

**Straight and Right-Angle Post with Retentive Legs**

### Connector Ordering Information



**Recommended Mounting Hole Pattern for .062 [1.57] Thk. PC Board**

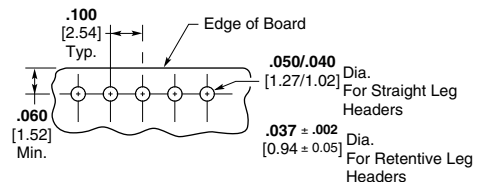

**Recommended Mounting Hole Pattern for .062 [1.57] Thk. PC Board**

**Note:** Consult Product Drawing for details on placing headers onto PC boards.

### Base Part Numbers

Straight Posts				Right-Angle Posts			
Without Retentive Legs		With Retentive Legs		Without Retentive Legs		With Retentive Legs	
Header Part Nos.	RoHS Equiv.	Header Part Nos.	RoHS Equiv.	Header Part Nos.	RoHS Equiv.	Header Part Nos.	RoHS Equiv.
<b>Standard UL94V-0, Tin Plated</b>							
644456	32-58	644695	32-58	644457	32-58	644694	32-58
<b>Standard UL94V-0, .000030 [0.00076] Gold Plated</b>							
644884	2-28	644886	2-28	644885	2-28	644887	2-28
<b>Standard UL94V-0, .000015 [0.00038] Gold Plated</b>							
644888	2-28	644890	2-28	644889	2-28	644891	2-28

High temperature product available. Please contact Sales Engineer or Product Information Center.

MTA-100 .100 [2.54]

## MTA-100 Polarized Headers—Straight and Right-Angle

### Material and Finish

**Housing**—UL94V-0 rated, polyester, white

**Posts**—Copper alloy, tin plated, .000030 [0.00076] or .000015 [0.00038] gold over nickel

**Notes:**

1. Post(s) can be omitted for keying purposes. Specify the desired post(s) to be omitted using the figure to identify Post No. 1.
2. Gold headers are duplex plated, gold on mating end of post and tin on the solder tail.
3. All posts on retentive leg headers are bent.
4. To determine header overall length (dim. A) multiply .100 x the number of posts. Example: .100 x 10 posts equals 1.000 inch [25.4 mm].

For mateability options, see matrix on pages 12 and 13.  
For mating half visuals, see pages 14, 15 and 31.

### Header Ordering Information

The “Base Part Numbers” Chart at right shows the base part number.

Prefixes and suffixes are determined by the number of post positions in the header. For example, the complete part number for a 10-position header with straight posts would be:

Base number **641213** plus prefix-and-suffix **4- -0**

The correct ordering number is **4-641213-0**

All part numbers are the RoHS equivalent version. Example:

No. of Pos.	Lead Free RoHS Prefix/Suffix
2	3-641213-2
	thru
28	5-641213-8

See page 15 for an explanation of RoHS lead free equivalents.

**Note:** All RoHS equivalent part numbers may not be available upon catalog release. If the number you need is not available, please contact Product Engineering to expedite your request.

**Note:** Select load headers (omitted pin headers) are available upon request. Please contact product engineer or product manager for details.

### Straight Post (.025 [0.64] Square)



### Right-Angle Post (.025 [0.64] Square)



Retentive Leg

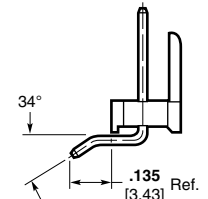

Retentive Leg



Recommended Mounting Hole Pattern for .062 [1.57] Thk. PC Board



Recommended Mounting Hole Pattern for .062 [1.57] Thk. PC Board

**Note:** Consult Product Drawing for details on placing headers onto PC boards.

### Base Part Numbers

Straight Posts				Right-Angle Posts			
Without Retentive Legs		With Retentive Legs		Without Retentive Legs		With Retentive Legs	
Header Part Nos.	RoHS Equiv.	Header Part Nos.	RoHS Equiv.	Header Part Nos.	RoHS Equiv.	Header Part Nos.	RoHS Equiv.
<b>Standard UL94V-0, Tin Plated</b>							
640454	2-28	644876	2-28	640455	2-28	644877	2-28
<b>Standard UL94V-0, .000030 [0.00076] Gold Plated</b>							
641213	32-58	—	—	641214	32-58	—	—
<b>Standard UL94V-0, .000015 [0.00038] Gold Plated</b>							
641124	32-58	—	—	641125	32-58	—	—

**MTA-100 Friction Lock Headers—Straight and Right-Angle**

**Material and Finish**

**Housing**—UL94V-0 rated, polyester, white

**Posts**—Copper alloy, tin plated, .000030 [0.00076] or .000015 [0.00038] gold over nickel

**Notes:**

1. Post(s) can be omitted for keying purposes. Specify the desired post(s) to be omitted using the figure to identify Post No. 1.
2. Gold headers are duplex plated, gold on mating end of post and tin on the solder tail.
3. All posts on retentive leg headers are bent.
4. To determine header overall length (dim. A) multiply .100 x the number of posts. Example: .100 x 10 posts equals 1.000 inch [25.4 mm].

For mateability options, see matrix on pages 12 and 13.

For mating half visuals, see pages 14, 15 and 31.

**Header Ordering Information**

The “Base Part Numbers” Chart at right shows the base part number.

Prefixes and suffixes are determined by the number of post positions in the header. For example, the complete part number for a 10-position header with straight posts would be:

Base number **641215** plus prefix-and-suffix **4- -0**

The correct ordering number is **4-641215-0**

All part numbers are the RoHS equivalent version. Example:

No. of Pos.	Standard Prefix/Suffix	Lead Free RoHS Prefix/Suffix
2	641215-2	3-641215-2
thru		
28	2-641215-8	5-641215-8

See page 15 for an explanation of RoHS lead free equivalents.

**Note:** All RoHS equivalent part numbers may not be available upon catalog release. If the number you need is not available, please contact Product Engineering to expedite your request.

**Note:** Select load headers (omitted pin headers) are available upon request. Please contact product engineer or product manager for details.

**Straight Post (.025 [0.64] Square)**



**Right-Angle Post (.025 [0.64] Square)**



**Note:** Consult Product Drawing for details on placing headers onto PC boards.

**Base Part Numbers**

Straight Posts				Right-Angle Posts			
Without Retentive Legs		With Retentive Legs		Without Retentive Legs		With Retentive Legs	
Header Part Nos.	RoHS Equiv.	Header Part Nos.	RoHS Equiv.	Header Part Nos.	RoHS Equiv.	Header Part Nos.	RoHS Equiv.
<b>Standard UL94V-0, Tin Plated</b>							
640456	2-28	644874	2-28	640457	2-28	644875	2-28
<b>Standard UL94V-0, .000030 [0.00076] Gold Plated</b>							
641215	32-58	—	—	641216	32-58	—	—
<b>Standard UL94V-0, .000015 [0.00038] Gold Plated</b>							
641126	32-58	—	—	641127	32-58	—	—

MTA-100 .100 [2.54]



**MTA-100 Headers with Retention Peg—Straight**

**Material and Finish**

**Housing**—UL94V-0 rated, thermo-plastic, black

**Posts**—Copper alloy, tin plated, .000030 [0.00076] or .000015 [0.00038] gold over nickel

**Notes:**

1. Post(s) can be omitted for keying purposes. Specify the desired post(s) to be omitted using the figure to identify Post No. 1.
2. Gold headers are duplex plated, gold on mating end of post and tin on the solder tail.
3. To determine header overall length (dim. A) multiply .100 x the number of posts. Example: .100 x 10 posts equals 1.000 inch [25.4 mm].

For mateability options, see matrix on pages 12 and 13.  
For mating half visuals, see pages 14, 15 and 31.

**Header Ordering Information**

The “Base Part Numbers” Chart at right shows the base part number.

Prefixes and suffixes are determined by the number of post positions in the header. For example, the complete part number for a 10-position header with straight posts would be:

Base number **647609** plus prefix-and-suffix  
**4—0**

The correct ordering number is **4-647609-0**

All part numbers are the RoHS equivalent version. Example:

No. of Pos.	Standard Prefix/Suffix	Lead Free RoHS Prefix/Suffix
2	647609-2	3-647609-2
3	647609-3	3-647609-3
4	647609-4	3-647609-4
5	647609-5	3-647609-5
6	647609-6	3-647609-6
7	647609-7	3-647609-7
8	647609-8	3-647609-8
9	647609-9	3-647609-9
10	1-647609-0	4-647609-0
11	1-647609-1	4-647609-1
12	1-647609-2	4-647609-2

**Note:** All RoHS equivalent part numbers may not be available upon catalog release. If the number you need is not available, please contact Product Engineering to expedite your request.

**Friction Lock**

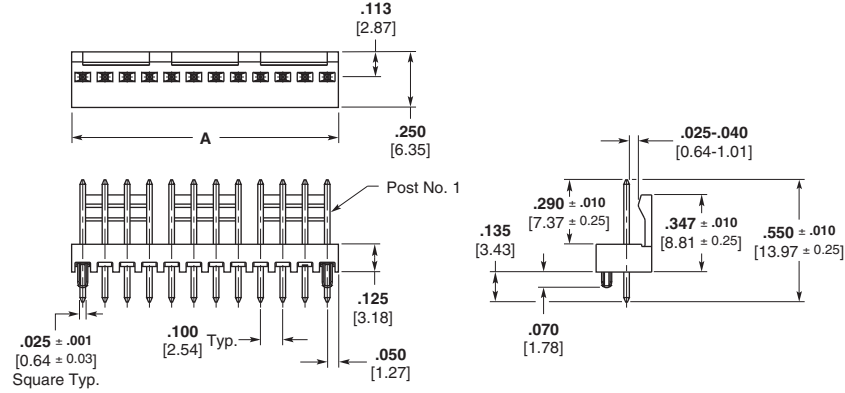

**Polarized**



**Recommended Mounting Hole Pattern for .062 [1.57] Thk. PC Board**

**Note:** Consult Product Drawing for details on placing headers onto PC boards.

**Base Part Numbers**

Friction Lock		Polarized	
Header Part Nos.	RoHS Equiv.	Header Part Nos.	RoHS Equiv.
<b>Standard UL94V-0, Tin Plated</b>			
647609	32-42	647623	32-42
<b>Standard UL94V-0, .000030 [0.00076] Gold Plated</b>			
647626	32-42	647624	32-42
<b>Standard UL94V-0, .000015 [0.00038] Gold Plated</b>			
647627	32-42	647625	32-42

**Note:**

Select load headers (omitted pin headers) are available upon request. Please contact product engineer or product manager for details.

MTA-100  
.100 [2.54]

## MTA-100 High Profile Headers—Right-Angle

### Material and Finish

**Housing**—UL94V-0 rated, thermo-plastic, black

**Posts**—Copper alloy, tin plated, .000030 [0.00076] or .000015 [0.00038] gold over nickel

#### Notes:

1. Post(s) can be omitted for keying purposes. Specify the desired post(s) to be omitted using the figure to identify Post No. 1.
2. Gold headers are duplex plated, gold on mating end of post and tin on the solder tail.
3. To determine header overall length (dim. A) multiply .100 x the number of posts. Example: .100 x 10 posts equals 1.000 inch [25.4 mm].
4. This product can be mounted in the middle of the PC Board as shown in the PCB layout.

For mateability options, see matrix on pages 12 and 13.

For mating half visuals, see pages 14, 15 and 31.

### Header Ordering Information

The "Base Part Numbers" Chart at right shows the base part number.

Prefixes and suffixes are determined by the number of post positions in the header. For example, the complete part number for a 10-position header with right-angle posts would be:

Base number **647630** plus prefix-and-suffix  
**4- -0**

The correct ordering number is **4-647630-0**

All part numbers are the RoHS equivalent version. Example:

No. of Pos.	Lead Free RoHS Prefix/Suffix
2	3-647630-2
3	3-647630-3
4	3-647630-4
5	3-647630-5
6	3-647630-6
7	3-647630-7
8	3-647630-8
9	3-647630-9
10	4-647630-0
11	4-647630-1
12	4-647630-2

**Note:** All RoHS equivalent part numbers may not be available upon catalog release. If the number you need is not available, please contact Product Engineering to expedite your request.

### Friction Lock

#### Right-Angle Post (.025 [0.64] Square)



### Polarized

#### Right-Angle Post (.025 [0.64] Square)



Recommended Mounting Hole Pattern for .062 [1.57] Thk. PC Board

**Note:** Consult Product Drawing for details on placing headers onto PC boards.

### Base Part Numbers

Friction Lock		Polarized	
Right-Angle Posts		Right-Angle Posts	
Header Part Nos.	RoHS Equiv.	Header Part Nos.	RoHS Equiv.
<b>Standard UL94V-0, Tin Plated</b>			
647630	32-42	647651	32-42
<b>Standard UL94V-0, .000030 [0.00076] Gold Plated</b>			
647629	32-42	647653	32-42
<b>Standard UL94V-0, .000015 [0.00038] Gold Plated</b>			
647628	32-42	647652	32-42

#### Note:

Select load headers (omitted pin headers) are available upon request. Please contact product engineer or product manager for details.

MTA-100  
.100 [2.54]

## MTA-100 Polarized High Temperature Headers—Straight and Right-Angle

### Material and Finish

#### Housing —

2–12 Position — UL94V-0 rated,  
nylon, black  
13–18 Position — UL94V-0 rated,  
LCP, black

**Posts**—Copper alloy, tin plated,  
.000030 [0.00076] or .000015  
[0.00038] gold over nickel

#### Notes:

1. Post(s) can be omitted for keying purposes. Specify the desired post(s) to be omitted using the figure to identify Post No. 1.
2. Gold headers are duplex plated, gold on mating end of post and tin on the solder tail.
3. To determine header overall length (dim. A) multiply .100 x the number of posts. Example: .100 x 10 posts equals 1.000 inch [25.4 mm].

For mateability options, see matrix on pages 12 and 13.

For mating half visuals, see pages 14, 15 and 31.

### Header Ordering Information

The “Base Part Numbers” Chart at right shows the base part number.

Prefixes and suffixes are determined by the number of post positions in the header. For example, the complete part number for a 10-position header with straight posts would be:

Base number **647047** plus  
prefix-and-suffix  
**4- -0**

The correct ordering number is  
**4-647047-0**

All part numbers are the RoHS equivalent version. Example:

No. of Pos.	Lead Free RoHS Prefix/Suffix
2	3-647047-2
	thru
12	4-647047-2
13	NA
	thru
18	NA

See page 15 for an explanation of RoHS lead free equivalents.

**Note:** All RoHS equivalent part numbers may not be available upon catalog release. If the number you need is not available, please contact Product Engineering to expedite your request.

### For use with Infrared Reflow Process

Maximum Temperature Rating: 2–12 Position: 280°C  
13–18 Position: 235°C

#### Straight Post (.025 [0.64] Square)



#### Right-Angle Post (.025 [0.64] Square)



**Note:** Consult Product Drawing for details on placing headers onto PC boards.

Recommended Mounting Hole Pattern for .062 [1.57] Thick PC Board

### Base Part Numbers

Straight Posts		Straight Posts (Tube Loaded)		Right-Angle Posts	
Header Part Nos.	RoHS Equiv.	Header Part Nos.	RoHS Equiv.	Header Part Nos.	RoHS Equiv.
<b>Standard UL94V-0, Tin Plated</b>					
647047	32-42	647298	32-42	647048	32-42
<b>Standard UL94V-0, .000030 [0.00076] Gold Plated</b>					
647109	32-42	647300	32-42	647114	32-42
<b>Standard UL94V-0, .000015 [0.00038] Gold Plated</b>					
647075	32-42	647299	32-42	647076	32-42

**Note:** Select load headers (omitted pin headers) are available upon request. Please contact product engineer or product manager for details.

## MTA-100 Friction Lock High Temperature Headers—Straight and Right-Angle

### Material and Finish

**Housing** —  
 2–12 Position — UL94V-0 rated, nylon, black  
 13–18 Position — UL94V-0 rated, LCP, black

**Posts** — Copper alloy, tin plated, .000030 [0.00076] or .000015 [0.00038] gold over nickel

#### Notes:

1. Post(s) can be omitted for keying purposes. Specify the desired post(s) to be omitted using the figure to identify Post No. 1.
2. Gold headers are duplex plated, gold on mating end of post and tin on the solder tail.
3. To determine header overall length (dim. A) multiply .100 x the number of posts. Example: .100 x 10 posts equals 1.000 inch [25.4 mm].

For mateability options, see matrix on pages 12 and 13.  
 For mating half visuals, see pages 14, 15 and 31.

### Header Ordering Information

The “Base Part Numbers” Chart at right shows the base part number.

Prefixes and suffixes are determined by the number of post positions in the header. For example, the complete part number for a 10-position header with straight posts would be:

Base number **647050** plus prefix-and-suffix **4- -0**

The correct ordering number is **4-647050-0**

All part numbers are the RoHS equivalent version. Example:

No. of Pos.	Standard Prefix/Suffix	Lead Free RoHS Prefix/Suffix
2	647050-2	3-647050-2
thru		
12	1-647050-2	4-647050-2
13	1-647050-3	NA
thru		
18	1-647050-8	NA

See page 15 for an explanation of RoHS lead free equivalents.

**Note:** All RoHS equivalent part numbers may not be available upon catalog release. If the number you need is not available, please contact Product Engineering to expedite your request.

### For use with Infrared Reflow Process

Maximum Temperature Rating: 2–12 Position: 280°C  
 13–18 Position: 235°C

#### Straight Post (.025 [0.64] Square)

#### Right-Angle Post (.025 [0.64] Square)



**Note:** Consult Product Drawing for details on placing headers onto PC boards.

Recommended Mounting Hole Pattern for .062 [1.57] Thick PC Board

### Base Part Numbers

Straight Posts		Straight Posts (Tube Loaded)		Right-Angle Posts	
Header Part Nos.	RoHS Equiv.	Header Part Nos.	RoHS Equiv.	Header Part Nos.	RoHS Equiv.
<b>Standard UL94V-0, Tin Plated</b>					
647050	32-42	647295	32-42	647051	32-42
<b>Standard UL94V-0, .000030 [0.00076] Gold Plated</b>					
647116	32-42	647297	32-42	647117	32-42
<b>Standard UL94V-0, .000015 [0.00038] Gold Plated</b>					
647078	32-42	647296	32-42	647079	32-42

**Note:** Select load headers (omitted pin headers) are available upon request. Please contact product engineer or product manager for details.

MTA-100  
 .100 [2.54]

## MTA-100 Polarized and Friction Lock Surface Mount Headers—Straight

### Material and Finish

#### Housing —

2–12 Position — UL94V-0 rated, nylon, black  
13–18 Position — UL94V-0 rated, LCP, black

**Posts** — Copper alloy, tin plated, .000030 [0.00076] or .000015 [0.00038] gold over nickel

#### Notes:

1. Post(s) can be omitted for keying purposes. Specify the desired post(s) to be omitted using the figure to identify Post No. 1.
2. Gold headers are duplex plated, gold on mating end of post and tin on the solder tail.
3. To determine header overall length (dim. A) multiply .100 x the number of posts. Example: .100 x 10 posts equals 1.000 inch [25.4 mm].

For mateability options, see matrix on pages 12 and 13.

For mating half visuals, see pages 14, 15 and 31.

### Header Ordering Information

The “Base Part Numbers” Chart at right shows the base part number.

Prefixes and suffixes are determined by the number of post positions in the header. For example, the complete part number for a 10-position surface mount polarized header would be:

Base number **647106** plus prefix-and-suffix  
**4- -0**

The correct ordering number is **4-647106-0**

All part numbers are the RoHS equivalent version. Example:

No. of Pos.	Lead Free RoHS Prefix/Suffix
2	3-647106-2
12	4-647106-2

See page 15 for an explanation of RoHS lead free equivalents.

**Note:** All RoHS equivalent part numbers may not be available upon catalog release. If the number you need is not available, please contact Product Engineering to expedite your request.

### For use with Infrared Reflow Process

Maximum Temperature Rating: 2–12 Position: 280°C  
13–18 Position: 235°C

#### Polarized Header



#### Friction Lock Header



**Note:** Consult Product Drawing for details on placing headers onto PC boards.

Recommended PC Board Layout for use with .010 [0.25] Thick Stencil

### Base Part Numbers

Polarized Headers		Friction Lock Headers	
Header Part Nos.	RoHS Equiv.	Header Part Nos.	RoHS Equiv.
<b>Standard UL94V-0, Tin Plated</b>			
647106	32-42	647166	32-42
<b>Standard UL94V-0, .000030 [0.00076] Gold Plated</b>			
647108	32-42	647168	32-42
<b>Standard UL94V-0, .000015 [0.00038] Gold Plated</b>			
647107	32-42	647167	32-42

### Tape Mount Part Numbers

Polarized Headers		Friction Lock Headers	
Header Part Nos.	RoHS Equiv.	Header Part Nos.	RoHS Equiv.
<b>Standard UL94V-0, Tin Plated</b>			
647531	32-42	647502	32-42
<b>Standard UL94V-0, .000030 [0.00076] Gold Plated</b>			
		1744163	32-42
<b>Standard UL94V-0, .000015 [0.00038] Gold Plated</b>			
		647467	32-42

**Note:** Select load headers (omitted pin headers) are available upon request. Please contact product engineer or product manager for details.

## MTA-100 Shrouded Headers—Straight and Right-Angle

### Material and Finish

**Housing**—UL94V-0 rated, polyester, black

**Posts**—Copper alloy, tin plated; or .000030 [0.00076] gold over nickel

**Notes:**

1. Post(s) can be omitted for keying purposes. Specify the desired post(s) to be omitted using the figure to identify Post No. 1.
2. Headers with .000015 [0.00038] gold plated post are available upon request. Minimums may apply.
3. Gold headers are duplex plated, gold on mating end of post and tin on the solder tail.

For mateability options, see matrix on pages 12 and 13.

For mating half visuals, see pages 14 and 15.

### Header Ordering Information

The “Base Part Numbers” Chart at right shows the base part number.

Prefixes and suffixes are determined by the number of post positions in the header. For example, the complete part number for a 10-position header with straight posts and with pegs would be:

Base number **644486** plus prefix-and-suffix **4- -0**

The correct ordering number is **4-644486-0**

See page 15 for an explanation of RoHS lead free equivalents.

**Note:** All RoHS equivalent part numbers may not be available upon catalog release. If the number you need is not available, please contact Product Engineering to expedite your request.

**Notes:**

1. Select load headers (omitted pin headers) are available upon request. Please contact product engineer or product manager for details.
2. MTA-100 shrouded headers do not mate with CST-100 II housings.

### Header Length

No. of Circuits	Dim. A	Prefix/Suffix
2	.284 7.21	3- -2
3	.384 9.75	3- -3
4	.484 12.29	3- -4
5	.584 14.83	3- -5

### Straight Post (.025 [0.64] Square)



### Right-Angle (.025 [0.64] Square)

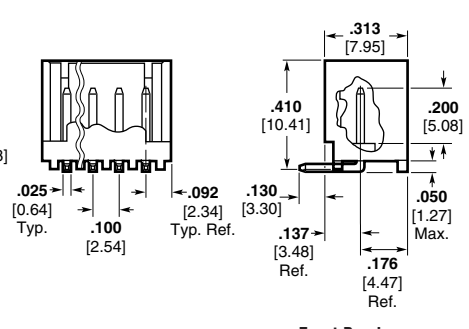

Front Bend



Rear Bend

**Note:** Consult Product Drawing for details on placing headers onto PC boards.

Recommended Mounting Hole Pattern for .062 [1.57] Thk. PC Board (Solder Side of Board Shown)

Recommended Mounting Hole Pattern for .062 [1.57] Thk. PC Board (Solder Side of Board Shown)

### Base Part Numbers

Straight Posts				Right-Angle Posts			
With Pegs		Without Pegs		Without Pegs Only		Without Pegs Only	
Header Part Nos.	RoHS Equiv.	Header Part Nos.	RoHS Equiv.	Front Bend Header Part Nos.	RoHS Equiv.	Rear Bend Header Part Nos.	RoHS Equiv.
<b>Standard UL94V-0, Tin Plated</b>							
644486	22-34	644861	22-34	644488	22-34	644803	22-34
<b>Standard UL94V-0, .000030 [0.00076] Gold Plated</b>							
644487	22-34	—	—	644489	22-34	—	—

### Header Length

No. of Circuits	Dim. A	Prefix/Suffix	No. of Circuits	Dim. A	Prefix/Suffix	No. of Circuits	Dim. A	Prefix/Suffix
2	.284 7.21	3- -2	6	.684 17.37	3- -6	10	1.084 27.53	4- -0
3	.384 9.75	3- -3	7	.784 19.91	3- -7	11	1.184 30.07	4- -1
4	.484 12.29	3- -4	8	.884 22.45	3- -8	12	1.284 32.61	4- -2
5	.584 14.83	3- -5	9	.984 24.99	3- -9	13	1.384 35.15	4- -3

## .100 [2.54] Centerline CST-100 II Crimp Contacts and Housings

### Product Facts

- Low cost wire-to-board interconnections
- Wide wire range for single contact
- Tin and gold plated contacts
- Mates with specified MTA and similar competitive notched headers
- Plastic latching feature in housing helps prevent contact backout
- Locking ramps and polarizing tabs are standard
- For keying purposes use keying plug 641994-1 (page 17)
- Recognized under the Component Program of Underwriters Laboratories Inc., File No. E28476
- Certified by Canadian Standards Association, File No. LR7189

For mateability options, see matrix on pages 12 and 13.

For mating half visuals, see pages 21 thru 29 and 32.

See page 15 for an explanation of RoHS lead free equivalents.

### Performance Data

**Voltage Rating** — 250 vac

**Current Rating** — 4 amp max.

**Low-Level Resistance** — 6 mΩ max. initial; 10 mΩ max. final

**Insulation Resistance** — 1000 MΩ min. initial; 100 MΩ min. final

**Operating Temperature** — -55° C to +105° C

### Technical Documents

**Product Specification**  
108-1948

**Application Specification**  
114-13036

**Instruction Sheet**  
408-8493



### Contacts

Part Numbers		
Tin Plated	15 Au Gold Plated	30 Au Gold Plated
1375819-1 (Strip)	1375819-2 (Strip)	1375819-3 (Strip)
1445336-1 (Loose Piece)	1445336-2 (Loose Piece)	1445336-3 (Loose Piece)

### Material and Finish (RoHS Compliant)

Phosphor bronze, pretinned or .000015 [.00038] gold, over nickel  
.000030 [0.00076] gold over nickel

**Wire Range** — 22–26 AWG [0.35–0.13 mm<sup>2</sup>]

**Max. Ins. Dia.** — .065 [1.65]

### Housing\*

#### Material (RoHS Compliant)

UL94V-0 rated, nylon, white

No. of Pos.	Dim. A	Part Numbers	No. of Pos.	Dim. A	Part Numbers
2	.220 5.59	1375820-2	16	1.620 41.15	1-1375820-6
3	.320 8.13	1375820-3	17	1.720 43.69	1-1375820-7
4	.420 10.67	1375820-4	18	1.820 46.23	1-1375820-8
5	.520 13.21	1375820-5	19	1.920 48.77	1-1375820-9
6	.620 15.75	1375820-6	20	2.020 51.31	2-1375820-0
7	.720 18.29	1375820-7	21	2.120 53.85	2-1375820-1
8	.820 20.83	1375820-8	22	2.220 56.39	2-1375820-2
9	.920 23.37	1375820-9	23	2.320 58.93	2-1375820-3
10	1.020 25.91	1-1375820-0	24	2.420 61.47	2-1375820-4
11	1.120 28.45	1-1375820-1	25	2.520 64.01	2-1375820-5
12	1.220 30.99	1-1375820-2	26	2.620 66.55	2-1375820-6
13	1.320 33.53	1-1375820-3	27	2.720 69.09	2-1375820-7
14	1.420 36.07	1-1375820-4	28	2.820 71.63	2-1375820-8
15	1.520 38.61	1-1375820-5			

### Application Tooling

#### Loose Piece Contacts —

Hand Tool No. 58517-3 (408-4064)

#### Strip Contacts —

AMP-O-LECTRIC Model "G"

Termination Machine\*

Applicator No. 567373-3

(Request Catalog 65828)

AMP-O-MATIC Stripper-Crimper

Machine\* Applicator No. 567910-1 or

567827-1 (with QQM) (Request Catalog 65004)

AMPOMATOR CLS IIIG Lead Making

Machine\* (Request Catalog 82659)

\*Requires applicators. For part numbers, call Technical Support.



\*Housings without polarizing tabs may be manufactured upon request. Minimums may apply. Contact product engineering or product manager for details.

## CST-100 II Shrouded Headers—Straight and Right-Angle

### Material and Finish

**Housing**—UL94V-0 rated, polyester, black

**Posts**—Copper alloy, tin plated; or .000030 [0.00076] gold over nickel

**Notes:**

1. Post(s) can be omitted for keying purposes. Specify the desired post(s) to be omitted using the figure to identify Post No. 1.
2. Headers with .000015 [0.00038] gold plated posts are available upon request. Minimums may apply.
3. Gold headers are duplex plated, gold on mating end of post and tin on the solder tail.

For mateability options, see matrix on pages 12 and 13.

For mating half visuals, see page 31.

### Header Ordering Information

The “Base Part Numbers” Chart at right shows the base part number and number of posts available for the described headers.

Prefixes and suffixes are determined by the number of post positions in the header. For example, the complete part number for a 10-position header with straight posts and with pegs would be:

Base number **644893** plus prefix-and-suffix **4- -0**

The correct ordering number is **4-644893-0**

All part numbers are the RoHS equivalent version. Example:

No. of Pos.	Lead Free RoHS Prefix/Suffix
2	3-644893-2
	thru
14	4-644893-4

See page 15 for an explanation of RoHS lead free equivalents.

**Note:** All RoHS equivalent part numbers may not be available upon catalog release. If the number you need is not available, please contact Product Engineering to expedite your request.

**Note:**

CST-100 II shrouded headers **only** mate with CST-100 II housings. All the MTA-100 headers except the MTA-100 shrouded headers mate with CST-100 II housings.

### Straight Post (.025 [0.64] Square)



Recommended Mounting Hole Pattern for .062 [1.57] Thk. PC Board (Solder Side of Board Shown)

### Right-Angle (.025 [0.64] Square)



Recommended Mounting Hole Pattern for .062 [1.57] Thk. PC Board (Solder Side of Board Shown)

**Note:** Consult Product Drawing for details on placing headers onto PC boards.

### Base Part Numbers

Straight Posts				Right-Angle Posts Without Pegs Only	
With Pegs		Without Pegs		Header Part Nos.	No. of Posts/RoHS Equiv.
Header Part Nos.	No. of Posts/RoHS Equiv.	Header Part Nos.	No. of Posts/RoHS Equiv.	Header Part Nos.	No. of Posts/RoHS Equiv.
<b>Standard UL94V-0, Tin Plated</b>					
644893	32-44	644892	32-44	644894	32-44
<b>Standard UL94V-0, .000030 [0.00076] Gold Plated</b>					
644897	32-44	644896	32-44	644898	32-44

### Header Length

No. of Circuits	Dim. A	Prefix/Suffix	No. of Circuits	Dim. A	Prefix/Suffix	No. of Circuits	Dim. A	Prefix/Suffix
2	.284 7.21	3- -2	5	.584 14.83	3- -5	8	.884 22.45	3- -8
3	.384 9.75	3- -3	6	.684 17.37	3- -6	9	.984 24.99	3- -9
4	.484 12.29	3- -4	7	.784 19.91	3- -7	10	1.084 27.53	4- -0

CST-100 II  
.100 [2.54]



## .156 [3.96] Centerline MTA-156 IDC Connectors and Headers

### Product Facts

- Connectors and headers for 2 through 24 positions; wire sizes of 18, 20, 22, 24 and 26 AWG [0.9–0.12 mm<sup>2</sup>]
- Connectors and headers, except shrouded headers, are end-to-end stackable
- Quad Connectors for higher current rating (page 54)
- Posted connectors for 2, 3, 4, 6, 9, 12, 15 and 24 positions
- Card edge connectors for 3, 6, 9, 12, 15, 18 and 20 through 24 positions
- Connectors preloaded with IDC contacts
- All contacts are slotted for insulation displacement (IDC) termination technique
- Connector styles include both closed end and feed-thru, with and without locking ramps and polarizing tabs
- Molded ribs on housing do not allow reverse mating
- Contacts are lubricated for fretting corrosion protection
- Benefits derived from the MTA-156 system include increases quality and ease of handling such as —
  - One-step assembly
  - No wire stripping
  - No contact damage
  - Reduced wiring errors
  - Simpler tooling
  - Simple maintenance and repair
- Meets the material requirements of Table 23.1 of UL 1410 Standards for Television Receiver and Video Products (wire-to-post connectors only)
- Recognized under the Component Program of Underwriters Laboratories Inc.,  File No. E28476
- Certified by Canadian Standards Association,  File No. LR7189



MTA-156 connectors accept discrete and ribbon cable wire sizes ranging from 18–26 AWG [0.9–0.12 mm<sup>2</sup>] with maximum insulation outside diameter .095 [2.41] for single wire and .070 [1.78] for mass termination of wires. Tin plated solid, fused stranded or stranded (7, 16, and 19 strands) wire with PVC insulation can be used on 18 AWG [0.8–0.9 mm<sup>2</sup>] MTA-156 connectors; 7, 10, and 19 stranded wire on 20 AWG [0.5–0.6 mm<sup>2</sup>] MTA-156 connectors; and 7 and 19 stranded wire on 22–26 AWG [0.4–0.12 mm<sup>2</sup>] MTA-156 connectors.

Only one wire to be terminated into an IDC contact slot.

Mass termination of wire provides the lowest applied cost because it drastically reduces the labor content of virtually any cable or harness assembly required.

The wire-to-post connector housing material is flame retardant thermoplastic, either UL94V-2 or UL94V-0 rated.

A full line of .156 [3.96] centerline headers completes the system. Headers are available with straight or right-angle posts, in flat friction lock and shrouded styles. Headers are available in 2 through 24 positions.

**Note:** Refer to page 70 for approved wire listings.

### Performance Data\*

**Voltage Rating**—600 vac

**Current Rating**—  
7 amp max. for MTA-156 Connector

**Low-Level Resistance**—  
3.0 mΩ max. initial

**Dielectric Withstanding Voltage**—  
2200 vac/1 min.

**Insulation Resistance**—  
5000 MΩ min. initial

**Operating Temperature**—  
–55° C to +105° C

\*Refer to the Product Specification for additional electrical, mechanical and environmental performance tests and requirements.

### Technical Documents

#### Product Specification

108-1051 MTA-156 Connectors

#### Application Specifications

114-1020 MTA-156 Connectors, Posted Connectors and Card Edge Connectors

114-1032 MTA-156 Ribbon Cable Assembly



### MTA-156 Connector/Header Mateability Guide (Continued)

This matrix has been prepared to assist you, our customer, in defining the correct mating halves for the MTA-156 header and connector combination. Where a "Y" is indicated the combination is a valid mating pair. Where an "N" is indicated the combination is not acceptable for mating.

Matrix for .000030  
[0.00076] Gold Plated  
Part Numbers

Connectors	Headers																										
	641202	641203	641204	641207	641208	641209	641210	644627	644628	644629	644630	644631	644632	644633	644756	644757	644758	644759	644760	644761	644762	647131	647132	647133	647134	647135	647136
641217	Y	Y	Y	N	Y	Y	Y	Y	Y	N	Y	Y	Y	Y	Y	Y	Y	Y	Y	N	Y	Y	Y	Y	Y	Y	Y
641218	Y	Y	Y	N	Y	Y	Y	Y	Y	N	Y	Y	Y	Y	Y	Y	Y	Y	Y	N	Y	Y	Y	Y	Y	Y	Y
641219	Y	Y	Y	N	Y	Y	Y	Y	Y	N	Y	Y	Y	Y	Y	Y	Y	Y	Y	N	Y	Y	Y	Y	Y	Y	Y
641220	Y	Y	Y	N	Y	Y	Y	Y	Y	N	Y	Y	Y	Y	Y	Y	Y	Y	Y	N	Y	Y	Y	Y	Y	Y	Y
641221	Y	Y	Y	N	Y	Y	Y	Y	Y	N	Y	Y	Y	Y	Y	Y	Y	Y	Y	N	Y	Y	Y	Y	Y	Y	Y
641222	Y	Y	Y	Y	Y	Y	Y	Y	Y	Y	Y	Y	Y	Y	Y	Y	Y	Y	Y	Y	Y	Y	Y	Y	Y	Y	Y
641223	Y	Y	Y	Y	Y	Y	Y	Y	Y	Y	Y	Y	Y	Y	Y	Y	Y	Y	Y	Y	Y	Y	Y	Y	Y	Y	Y
641224	Y	Y	Y	Y	Y	Y	Y	Y	Y	Y	Y	Y	Y	Y	Y	Y	Y	Y	Y	Y	Y	Y	Y	Y	Y	Y	Y
641225	Y	Y	Y	Y	Y	Y	Y	Y	Y	Y	Y	Y	Y	Y	Y	Y	Y	Y	Y	Y	Y	Y	Y	Y	Y	Y	Y
641226	Y	Y	Y	Y	Y	Y	Y	Y	Y	Y	Y	Y	Y	Y	Y	Y	Y	Y	Y	Y	Y	Y	Y	Y	Y	Y	Y
641227	Y	Y	Y	N	Y	Y	Y	Y	Y	N	Y	Y	Y	Y	Y	Y	Y	Y	Y	N	Y	Y	Y	Y	Y	Y	Y
641228	Y	Y	Y	N	Y	Y	Y	Y	Y	N	Y	Y	Y	Y	Y	Y	Y	Y	Y	N	Y	Y	Y	Y	Y	Y	Y
641229	Y	Y	Y	N	Y	Y	Y	Y	Y	N	Y	Y	Y	Y	Y	Y	Y	Y	Y	N	Y	Y	Y	Y	Y	Y	Y
641230	Y	Y	Y	N	Y	Y	Y	Y	Y	N	Y	Y	Y	Y	Y	Y	Y	Y	Y	N	Y	Y	Y	Y	Y	Y	Y
641231	Y	Y	Y	N	Y	Y	Y	Y	Y	N	Y	Y	Y	Y	Y	Y	Y	Y	Y	N	Y	Y	Y	Y	Y	Y	Y
641232	Y	Y	Y	Y	Y	Y	Y	Y	Y	Y	Y	Y	Y	Y	Y	Y	Y	Y	Y	Y	Y	Y	Y	Y	Y	Y	Y
641233	Y	Y	Y	Y	Y	Y	Y	Y	Y	Y	Y	Y	Y	Y	Y	Y	Y	Y	Y	Y	Y	Y	Y	Y	Y	Y	Y
641234	Y	Y	Y	Y	Y	Y	Y	Y	Y	Y	Y	Y	Y	Y	Y	Y	Y	Y	Y	Y	Y	Y	Y	Y	Y	Y	Y
641235	Y	Y	Y	Y	Y	Y	Y	Y	Y	Y	Y	Y	Y	Y	Y	Y	Y	Y	Y	Y	Y	Y	Y	Y	Y	Y	Y
641236	Y	Y	Y	Y	Y	Y	Y	Y	Y	Y	Y	Y	Y	Y	Y	Y	Y	Y	Y	Y	Y	Y	Y	Y	Y	Y	Y
644460	Y	Y	Y	N	Y	Y	Y	Y	Y	N	Y	Y	Y	Y	Y	Y	Y	Y	Y	N	Y	Y	Y	Y	Y	Y	Y
644662	Y	Y	Y	N	Y	Y	Y	Y	Y	N	Y	Y	Y	Y	Y	Y	Y	Y	Y	N	Y	Y	Y	Y	Y	Y	Y
644663	Y	Y	Y	N	Y	Y	Y	Y	Y	N	Y	Y	Y	Y	Y	Y	Y	Y	Y	N	Y	Y	Y	Y	Y	Y	Y
644687	Y	Y	Y	Y	Y	Y	Y	Y	Y	Y	Y	Y	Y	Y	Y	Y	Y	Y	Y	Y	Y	Y	Y	Y	Y	Y	Y
644718	Y	Y	Y	N	Y	Y	Y	Y	Y	N	Y	Y	Y	Y	Y	Y	Y	Y	Y	N	Y	Y	Y	Y	Y	Y	Y
644720	Y	Y	Y	N	Y	Y	Y	Y	Y	N	Y	Y	Y	Y	Y	Y	Y	Y	Y	N	Y	Y	Y	Y	Y	Y	Y

Matrix for .000015  
[0.00038] Gold Plated  
Part Numbers

Connectors	Headers																										
	641113	641114	641115	641118	641119	641120	641121	644763	644764	644765	644766	644767	644768	644769	647139	647140	647141	647142	647143	647144	647649						
641148	Y	Y	Y	N	Y	Y	Y	Y	Y	Y	Y	Y	N	Y	Y	Y	Y	Y	Y	Y	Y	Y	Y	Y	Y	Y	
641149	Y	Y	Y	N	Y	Y	Y	Y	Y	Y	Y	Y	N	Y	Y	Y	Y	Y	Y	Y	Y	Y	Y	Y	Y	Y	
641150	Y	Y	Y	N	Y	Y	Y	Y	Y	Y	Y	Y	N	Y	Y	Y	Y	Y	Y	Y	Y	Y	Y	Y	Y	Y	
641151	Y	Y	Y	N	Y	Y	Y	Y	Y	Y	Y	Y	N	Y	Y	Y	Y	Y	Y	Y	Y	Y	Y	Y	Y	Y	
641152	Y	Y	Y	N	Y	Y	Y	Y	Y	Y	Y	Y	N	Y	Y	Y	Y	Y	Y	Y	Y	Y	Y	Y	Y	Y	
641153	Y	Y	Y	Y	Y	Y	Y	Y	Y	Y	Y	Y	Y	Y	Y	Y	Y	Y	Y	Y	Y	Y	Y	Y	Y	Y	
641154	Y	Y	Y	Y	Y	Y	Y	Y	Y	Y	Y	Y	Y	Y	Y	Y	Y	Y	Y	Y	Y	Y	Y	Y	Y	Y	
641155	Y	Y	Y	Y	Y	Y	Y	Y	Y	Y	Y	Y	Y	Y	Y	Y	Y	Y	Y	Y	Y	Y	Y	Y	Y	Y	
641156	Y	Y	Y	Y	Y	Y	Y	Y	Y	Y	Y	Y	Y	Y	Y	Y	Y	Y	Y	Y	Y	Y	Y	Y	Y	Y	
641157	Y	Y	Y	Y	Y	Y	Y	Y	Y	Y	Y	Y	Y	Y	Y	Y	Y	Y	Y	Y	Y	Y	Y	Y	Y	Y	
641168	Y	Y	Y	N	Y	Y	Y	Y	Y	Y	Y	Y	N	Y	Y	Y	Y	Y	Y	Y	Y	Y	Y	Y	Y	Y	
641169	Y	Y	Y	N	Y	Y	Y	Y	Y	Y	Y	Y	N	Y	Y	Y	Y	Y	Y	Y	Y	Y	Y	Y	Y	Y	
641170	Y	Y	Y	N	Y	Y	Y	Y	Y	Y	Y	Y	N	Y	Y	Y	Y	Y	Y	Y	Y	Y	Y	Y	Y	Y	
641171	Y	Y	Y	N	Y	Y	Y	Y	Y	Y	Y	Y	N	Y	Y	Y	Y	Y	Y	Y	Y	Y	Y	Y	Y	Y	
641172	Y	Y	Y	N	Y	Y	Y	Y	Y	Y	Y	Y	N	Y	Y	Y	Y	Y	Y	Y	Y	Y	Y	Y	Y	Y	
641173	Y	Y	Y	Y	Y	Y	Y	Y	Y	Y	Y	Y	Y	Y	Y	Y	Y	Y	Y	Y	Y	Y	Y	Y	Y	Y	
641174	Y	Y	Y	Y	Y	Y	Y	Y	Y	Y	Y	Y	Y	Y	Y	Y	Y	Y	Y	Y	Y	Y	Y	Y	Y	Y	
641175	Y	Y	Y	Y	Y	Y	Y	Y	Y	Y	Y	Y	Y	Y	Y	Y	Y	Y	Y	Y	Y	Y	Y	Y	Y	Y	
641176	Y	Y	Y	Y	Y	Y	Y	Y	Y	Y	Y	Y	Y	Y	Y	Y	Y	Y	Y	Y	Y	Y	Y	Y	Y	Y	
641177	Y	Y	Y	Y	Y	Y	Y	Y	Y	Y	Y	Y	Y	Y	Y	Y	Y	Y	Y	Y	Y	Y	Y	Y	Y	Y	
644284	Y	Y	Y	N	Y	Y	Y	Y	Y	Y	Y	Y	N	Y	Y	Y	Y	Y	Y	Y	Y	Y	Y	Y	Y	Y	
647478	Y	Y	Y	N	Y	Y	Y	Y	Y	Y	Y	Y	N	Y	Y	Y	Y	Y	Y	Y	Y	Y	Y	Y	Y	Y	
647479	Y	Y	Y	N	Y	Y	Y	Y	Y	Y	Y	Y	N	Y	Y	Y	Y	Y	Y	Y	Y	Y	Y	Y	Y	Y	
647496	Y	Y	Y	Y	Y	Y	Y	Y	Y	Y	Y	Y	Y	Y	Y	Y	Y	Y	Y	Y	Y	Y	Y	Y	Y	Y	Y

**MTA-156 IDC Connectors—Closed End**

**Material and Finish**

**Housing** — UL94V-2 rated, nylon, see below for color; or UL94V-0 rated, nylon, black

**Contacts** — Phosphor bronze, post tin plated, .000030 [0.00076] or .000015 [.00038] post gold plated over nickel

**Color Coding by Wire Size for UL94V-2 Connectors**

- 26 AWG — Blue
- 24 AWG — White
- 22 AWG — Red
- 20 AWG — Yellow
- 18 AWG — Orange

**All Wire Sizes in UL94V-0** — Black

**Notes:**

1. Only connectors with locking ramp and without polarizing tabs mate with posted connectors on page 45.
2. Refer to pages 70 thru 74 for approved wire listing.
3. For strain reliefs and dust covers, see pages 40 and 41.
4. For keying plugs and panel mount end caps, see page 42.
5. Other circuit sizes are available upon request. Minimums may apply.
6. Connector circuits can be molded closed for keying purposes. Minimums may apply.
7. Where no part numbers appear in the chart, parts can be made available upon request. Minimums may apply.
8. To determine connector overall length (Dim. A), multiply .156 x the number of circuits. Example: .156 x 10 circuits equals 1.560 inches [39.62 mm].

**Closed End with Locking Ramp**



without Polarizing Tabs



with Polarizing Tabs

For mateability options, see matrix on pages 34 and 35.

Mating half visuals for Closed End Connectors with Locking Ramp, see pages 45 thru 48, 50, 52, and 53, (49 and 51 Front Bend Headers Only).

**Closed End without Locking Ramp**



without Polarizing Tabs



with Polarizing Tabs

For mateability options, see matrix on pages 34 and 35.

Mating half visuals for Closed End Connectors without Locking Ramp, see pages 46 thru 53.

MTA-156  
.156 [3.96]

**MTA-156 IDC Connectors—Closed End** (Continued)

**Connector Ordering Information**

The “Base Part Numbers” Chart at right shows the base part number and number of circuits available for the described connectors.

Prefixes and suffixes are determined by the number of circuit positions in the connector. For example, the complete part number for a 10-position closed end connector with locking ramp and without polarizing tabs for 18 AWG wire would be:

Base number **640426** plus prefix-and-suffix

**4- -0**

The correct ordering number is

**4-640426-0**

All part numbers in **bold face** are the RoHS equivalent version. Example:

No. of Pos.	Lead Free RoHS Prefix/Suffix
2	3-640426-2
3	3-640426-3
4	3-640426-4
5	3-640426-5
6	3-640426-6
7	3-640426-7
8	3-640426-8
9	3-640426-9
10	4-640426-0
11	4-640426-1
12	4-640426-2
13	4-640426-3
14	4-640426-4
15	4-640426-5
16	4-640426-6
17	4-640426-7
18	4-640426-8
19	4-640426-9
20	5-640426-0
21	5-640426-1
22	5-640426-2
23	5-640426-3
24	5-640426-4

**Note:** All RoHS equivalent part numbers may not be available upon catalog release. If the number you need is not available, please contact Product Engineering to expedite your request.

**Base Part Numbers**

Connector Type & Wire Size	Closed End with Locking Ramp				Closed End without Locking Ramp			
	Without Tabs		With Tabs		Without Tabs		With Tabs	
	Connector Part Nos.	Connector RoHS Equiv.	Connector Part Nos.	Connector RoHS Equiv.	Connector Part Nos.	RoHS Equiv.	Part Nos.	RoHS Equiv.
<b>Standard UL94V-2, Tin Plated</b>								
<b>18 AWG</b> 0.8–0.9 mm <sup>2</sup>	640426	<b>32–54</b>	643817	<b>32–54</b>	640431	<b>32–54</b>	644461 <sup>1</sup>	<b>32–44</b>
<b>20 AWG</b> 0.5–0.6 mm <sup>2</sup>	640427	<b>32–54</b>	643818	<b>32–54</b>	640432	<b>32–54</b>	644462 <sup>1</sup>	<b>32–44</b>
<b>22 AWG</b> 0.3–0.4 mm <sup>2</sup>	640428	<b>32–54</b>	643819	<b>32–54</b>	640433	<b>32–54</b>	644463 <sup>1</sup>	<b>32–44</b>
<b>24 AWG</b> 0.2 mm <sup>2</sup>	640429	<b>32–54</b>	643820	<b>32–54</b>	640434	<b>32–54</b>	644464 <sup>1</sup>	<b>32–44</b>
<b>26 AWG</b> 0.12–0.15 mm <sup>2</sup>	640430	<b>32–54</b>	643821	<b>32–54</b>	640435	<b>32–54</b>	—	—
<b>Tape Mounted on Reel UL94V-2, Tin Plated</b>								
<b>18 AWG</b> 0.8–0.9 mm <sup>2</sup>	640472	<b>32–54</b>	644878	<b>32–54</b>	640477	<b>32–54</b>	—	—
<b>20 AWG</b> 0.5–0.6 mm <sup>2</sup>	640473	<b>32–54</b>	—	—	640478	<b>32–54</b>	—	—
<b>22 AWG</b> 0.3–0.4 mm <sup>2</sup>	640474	<b>32–54</b>	644783	<b>32–54</b>	640479	<b>32–54</b>	644791 <sup>1</sup>	<b>32–44</b>
<b>24 AWG</b> 0.2 mm <sup>2</sup>	640475	<b>32–54</b>	—	—	640480	<b>32–54</b>	—	—
<b>26 AWG</b> 0.12–0.15 mm <sup>2</sup>	640476	<b>32–54</b>	—	—	640481	<b>32–54</b>	—	—
<b>Standard UL94V-2, .000030 [0.00076] Gold Plated</b>								
<b>18 AWG</b> 0.8–0.9 mm <sup>2</sup>	641217	<b>32–54</b>	644460 <sup>1</sup>	<b>32–42</b>	641222	<b>32–54</b>	—	—
<b>20 AWG</b> 0.5–0.6 mm <sup>2</sup>	641218	<b>32–54</b>	644663 <sup>1</sup>	<b>32–42</b>	641223	<b>32–54</b>	—	—
<b>22 AWG</b> 0.3–0.4 mm <sup>2</sup>	641219	<b>32–54</b>	644662 <sup>1</sup>	<b>32–42</b>	641224	<b>32–54</b>	644687 <sup>1</sup>	<b>32–44</b>
<b>24 AWG</b> 0.2 mm <sup>2</sup>	641220	<b>32–54</b>	—	—	641225	<b>32–54</b>	—	—
<b>26 AWG</b> 0.12–0.15 mm <sup>2</sup>	641221	<b>32–54</b>	—	—	641226	<b>32–54</b>	—	—
<b>Standard UL94V-2, .000015 [0.00038] Gold Plated</b>								
<b>18 AWG</b> 0.8–0.9 mm <sup>2</sup>	641148	<b>32–54</b>	644284 <sup>1</sup>	<b>32–42</b>	641153	<b>32–54</b>	—	—
<b>20 AWG</b> 0.5–0.6 mm <sup>2</sup>	641149	<b>32–54</b>	—	—	641154	<b>32–54</b>	—	—
<b>22 AWG</b> 0.3–0.4 mm <sup>2</sup>	641150	<b>32–54</b>	647478 <sup>1</sup>	<b>32–42</b>	641155	<b>32–54</b>	—	—
<b>24 AWG</b> 0.2 mm <sup>2</sup>	641151	<b>32–54</b>	—	—	641156	<b>32–54</b>	—	—
<b>26 AWG</b> 0.12–0.15 mm <sup>2</sup>	641152	<b>32–54</b>	—	—	641157	<b>32–54</b>	—	—
<b>Standard UL94V-0, Tin Plated (Black in color)</b>								
<b>18 AWG</b> 0.8–0.9 mm <sup>2</sup>	644860 <sup>1</sup>	<b>32–42</b>	—	—	644502 <sup>1</sup>	<b>32–42</b>	644082 <sup>1</sup>	<b>32–42</b>
<b>22 AWG</b> 0.3–0.4 mm <sup>2</sup>	—	—	—	—	644501 <sup>1</sup>	<b>32–42</b>	644566 <sup>1</sup>	<b>32–42</b>

<sup>1</sup> Other circuit sizes are available upon request. Minimums may apply.

**Note:** Blocked circuit configurations are available upon request. Contact product engineer or product manager for details. Minimums may apply.

**MTA-156 IDC Connectors—Feed-Thru**

**Material and Finish**

**Housing** — UL94V-2 rated, nylon, see below for color; or UL94V-0 rated, nylon, black

**Contacts** — Phosphor bronze; post tin plated, .000030 [.00076] or .000015 [.00038] post gold plated over nickel

**Color Coding by Wire Size for UL94V-2 Connectors**

- 26 AWG — Blue
- 24 AWG — White
- 22 AWG — Red
- 20 AWG — Yellow
- 18 AWG — Orange

**All Wire Sizes in UL94V-0** — Black

**Notes:**

1. Only connectors with locking ramp and without polarizing tabs mate with posted connectors on page 45.
2. Refer to pages 70 thru 74 for approved wire listing.
3. For strain reliefs and dust covers, see pages 40 and 41.
4. For keying plugs and panel mount end caps, see page 42.
5. Other circuit sizes are available upon request. Minimums may apply.
6. Connector circuits can be molded closed for keying purposes. Minimums may apply.
7. Where no part numbers appear in the chart, parts can be made available upon request. Minimums may apply.
8. To determine connector overall length (Dim. A), multiply .156 x the number of circuits. Example: .156 x 10 circuits equals 1.560 inches [39.62 mm].

**Feed-Thru with Locking Ramp**



without Polarizing Tabs



with Polarizing Tabs

For mateability options, see matrix on pages 34 and 35.

Mating half visuals for Feed-Thru Connectors with Locking Ramp, see pages 45 thru 48, 50, 52, and 53, (49 and 51 Front Bend Headers Only).

**Feed-Thru without Locking Ramp**



without Polarizing Tabs



with Polarizing Tabs

For mateability options, see matrix on pages 34 and 35.

Mating half visuals for Feed-Thru Connectors without Locking Ramp, see pages 46 thru 53.

MTA-156 .156 [3.96]

### MTA-156 IDC Connectors—Feed-Thru (Continued)

#### Connector Ordering Information

The “Base Part Numbers” Chart at right shows the base part number and number of circuits available for the described connectors.

Prefixes and suffixes are determined by the number of circuit positions in the connector. For example, the complete part number for a 10-position feed-thru connector with locking ramp and without polarizing tabs for 18 AWG wire would be:

Base number **640599** plus  
prefix-and-suffix  
**4- -0**

The correct ordering number is

**4-640599-0**

The part numbers in **bold face** are the RoHS equivalent version. Example:

No. of Pos.	Lead Free RoHS Prefix/Suffix
2	3-640599-2
3	3-640599-3
4	3-640599-4
5	3-640599-5
6	3-640599-6
7	3-640599-7
8	3-640599-8
9	3-640599-9
10	4-640599-0
11	4-640599-1
12	4-640599-2
13	4-640599-3
14	4-640599-4
15	4-640599-5
16	4-640599-6
17	4-640599-7
18	4-640599-8
19	4-640599-9
20	5-640599-0
21	5-640599-1
22	5-640599-2
23	5-640599-3
24	5-640599-4

**Note:** All RoHS equivalent part numbers may not be available upon catalog release. If the number you need is not available, please contact Product Engineering to expedite your request.

#### Base Part Numbers

Connector Type & Wire Size	Feed-Thru with Locking Ramp				Feed-Thru without Locking Ramp			
	Without Tabs		With Tabs		Without Tabs		With Tabs	
	Connector Part Nos.	Connector RoHS Equiv.	Connector Part Nos.	RoHS Equiv.	Connector Part Nos.	RoHS Equiv.	Part Nos.	RoHS Equiv.
<b>Standard UL94V-2, Tin Plated</b>								
<b>18 AWG</b> 0.8–0.9 mm <sup>2</sup>	640599	<b>32-54</b>	644465 <sup>1</sup>	<b>32-44</b>	640604	<b>32-54</b>	644469 <sup>1</sup>	<b>32-44</b>
<b>20 AWG</b> 0.5–0.6 mm <sup>2</sup>	640600	<b>32-54</b>	644466 <sup>1</sup>	<b>32-44</b>	640605	<b>32-54</b>	644470 <sup>1</sup>	<b>32-44</b>
<b>22 AWG</b> 0.3–0.4 mm <sup>2</sup>	640601	<b>32-54</b>	644467 <sup>1</sup>	<b>32-44</b>	640606	<b>32-54</b>	644471 <sup>1</sup>	<b>32-44</b>
<b>24 AWG</b> 0.2 mm <sup>2</sup>	640602	<b>32-54</b>	644468 <sup>1</sup>	<b>32-44</b>	640607	<b>32-54</b>	644472 <sup>1</sup>	<b>32-44</b>
<b>26 AWG</b> 0.12–0.15 mm <sup>2</sup>	640595	<b>32-54</b>	—	—	640608	<b>32-54</b>	—	—
<b>Tape Mounted on Reel UL94V-2, Tin Plated</b>								
<b>18 AWG</b> 0.8–0.9 mm <sup>2</sup>	641302	<b>32-54</b>	—	—	641306	<b>32-54</b>	—	—
<b>20 AWG</b> 0.5–0.6 mm <sup>2</sup>	641303	<b>32-54</b>	—	—	641307	<b>32-54</b>	—	—
<b>22 AWG</b> 0.3–0.4 mm <sup>2</sup>	641304	<b>32-54</b>	—	—	641308	<b>32-54</b>	—	—
<b>24 AWG</b> 0.2 mm <sup>2</sup>	641305	<b>32-54</b>	—	—	641309	<b>32-54</b>	—	—
<b>26 AWG</b> 0.12–0.15 mm <sup>2</sup>	641301	<b>32-54</b>	—	—	641310	<b>32-54</b>	—	—
<b>Standard UL94V-2, .00003 [.00076] Gold Plated</b>								
<b>18 AWG</b> 0.8–0.9 mm <sup>2</sup>	641227	<b>32-54</b>	644718 <sup>1</sup>	<b>32-44</b>	641232	<b>32-54</b>	—	—
<b>20 AWG</b> 0.5–0.6 mm <sup>2</sup>	641228	<b>32-54</b>	—	—	641233	<b>32-54</b>	—	—
<b>22 AWG</b> 0.3–0.4 mm <sup>2</sup>	641229	<b>32-54</b>	644720 <sup>1</sup>	<b>32-44</b>	641234	<b>32-54</b>	—	—
<b>24 AWG</b> 0.2 mm <sup>2</sup>	641230	<b>32-54</b>	—	—	641235	<b>32-54</b>	—	—
<b>26 AWG</b> 0.12–0.15 mm <sup>2</sup>	641231	<b>32-54</b>	—	—	641236	<b>32-54</b>	—	—
<b>Standard UL94V-2, .000015 [.00038] Gold Plated</b>								
<b>18 AWG</b> 0.8–0.9 mm <sup>2</sup>	641168	<b>32-54</b>	647479 <sup>1</sup>	<b>32-42</b>	641173	<b>32-54</b>	—	—
<b>20 AWG</b> 0.5–0.6 mm <sup>2</sup>	641169	<b>32-54</b>	—	—	641174	<b>32-54</b>	—	—
<b>22 AWG</b> 0.3–0.4 mm <sup>2</sup>	641170	<b>32-54</b>	647496 <sup>1</sup>	<b>32-42</b>	641175	<b>32-54</b>	—	—
<b>24 AWG</b> 0.2 mm <sup>2</sup>	641171	<b>32-54</b>	—	—	641176	<b>32-54</b>	—	—
<b>26 AWG</b> 0.12–0.15 mm <sup>2</sup>	641172	<b>32-54</b>	—	—	641177	<b>32-54</b>	—	—
<b>Standard UL94V-0, Tin Plated</b>								
<b>18 AWG</b> 0.8–0.9 mm <sup>2</sup>	—	—	—	—	644567 <sup>1</sup>	<b>32-42</b>	644570 <sup>1</sup>	<b>32-42</b>
<b>22 AWG</b> 0.3–0.4 mm <sup>2</sup>	—	—	—	—	644569 <sup>1</sup>	<b>32-42</b>	644572 <sup>1</sup>	<b>32-42</b>

<sup>1</sup> Other circuit sizes are available upon request. Minimums may apply.

**Note:** Blocked circuit configurations are available upon request. Contact product engineer or product manager for details. Minimums may apply.

MTA-156  
.156 [3.96]

**MTA-156 Connector Accessories**

**Closed End Covers**

**Material (RoHS Compliant)**

**Strain Relief Covers** — UL94V-2 rated, nylon, white

**Dust Covers** — UL94V-0 rated, polyester, white

**Strain Relief Covers**



Note: This portion of front locking bar may or may not be present

**Dust Covers**



**Base Part Numbers**

Closed End			
Strain Relief Covers		Dust Covers	
Cover Part Nos.	No. of Circuits	Cover Part Nos.	No. of Circuits
643067	2-24	640551	2-24

**Feed-Thru Covers**

**Material (RoHS Compliant)**

**Strain Relief Covers** — UL94V-2 rated, nylon, white

**Dust Covers** — UL94V-0 rated, polyester, white

**Strain Relief Covers**



Note: This portion of front locking bar may or may not be present

**Dust Covers**



**Base Part Numbers**

Feed-Thru			
Strain Relief Covers		Dust Covers	
Cover Part Nos.	No. of Circuits	Cover Part Nos.	No. of Circuits
643071	2-24	640643	2-24

**Cover Ordering Information**

The "Base Part Numbers" Chart at right shows the base part number and number of circuits available for the described cover.

Prefixes and suffixes are determined by the number of circuit positions in the cover. For example, the complete part number for a 10-position closed-end strain relief cover would be:

Base number **643067** plus prefix-and-suffix

**1 — -0**

The correct ordering number is

**1-643067-0**

**Cover Length**

No. of Circuits	Dim. A	Prefix/Suffix	No. of Circuits	Dim. A	Prefix/Suffix	No. of Circuits	Dim. A	Prefix/Suffix
2	.312 7.92	-2	10	1.560 39.62	1- -0	18	2.808 71.32	1- -8
3	.468 11.89	-3	11	1.716 43.59	1- -1	19	2.964 75.29	1- -9
4	.624 15.85	-4	12	1.872 47.55	1- -2	20	3.120 79.25	2- -0
5	.780 19.81	-5	13	2.028 51.51	1- -3	21	3.276 83.21	2- -1
6	.936 23.77	-6	14	2.184 55.47	1- -4	22	3.432 87.17	2- -2
7	1.092 27.74	-7	15	2.340 59.44	1- -5	23	3.588 91.14	2- -3
8	1.248 31.7	-8	16	2.496 63.4	1- -6	24	3.744 95.1	2- -4
9	1.404 35.66	-9	17	2.652 67.36	1- -7			

MTA-156  
.156 [3.96]



## MTA-156 Connector Accessories (Continued)

### Replacement IDC Contacts

#### Material and Finish

**Contacts** — Phosphor bronze, post tin plated; .000030 [0.00076] or .000015 [0.00038] post gold plated over nickel

**Note:** Tyco Electronics does not recommend terminating an MTA contact more than one time. Use replacement contacts when required for field repairs or wire changes.



Wire Size		Part Numbers		
AWG	mm <sup>2</sup>	Tin Plated	.000030 [0.00076] Gold Plated	.000015 [0.00038] Gold Plated
18	0.8–0.9	640631-3	641143-4	641143-3
20	0.5–0.6	640632–3	641144-4	641144-3
22	0.3–0.4	640633-3	641145-4	641145-3
24	0.2	640634-3	641146-4	641146-3
26	0.12–0.15	640635-3	641147-4	641147-3

### Crimp Snap-in Contacts

#### Material and Finish

**Contacts** — Phosphor bronze, tin plated



Wire Size		Part Nos.	
AWG	mm <sup>2</sup>	Loose Piece*	Strip**
26–22	.12–0.3	640557-3	640556-3
22–18	0.3–0.9	640559-3	640558-3

\*Hand Tool No. 59837-1 (408-6528)  
\*\*AMP-O-LECTRIC Model "G" Termination Machine (Request Catalog 65828)  
**Note:** Requires applicator. For part number, call Technical Support.

Special applications for crimp snap-in contacts are:

1. Double wire per contact
2. Coax or shielded wire
3. Mixed wire size in same connector

**Note:** Only one crimp snap-in contact per connector.

**MTA-156 Connector Accessories** (Continued)

**Keying Plugs**

**Material (RoHS Compliant)**

UL94V-2 rated, nylon, natural color

**Note:** Removal of contact is not necessary when using keying plug.

**Loose Piece**

**Part No. 640629-1 (Flush)**  
Used with keyed headers



**On Carrier Strip**

**Part No. 641623-1 (Flush)**  
(10 per strip)



**Part No. 640630-1 (Long Nose)**  
Used with staked post



**Panel Mount End Caps**

**Part No. 641440-1**  
**Part No. 641533-1**  
(2-position only)

**Material (RoHS Compliant)**

UL94V-2 rated, nylon, black

**Notes:**

- Both left-hand and right-hand end caps are attached by a connecting tab. This tab must be broken off prior to installing on connector.
- For best results attach panel mount end caps to the MTA-156 (IDC) connectors shown on pages 36 thru 39. While not preferred, panel mount end caps can be attached to MTA-156 (IDC) posted connector on page 45.



**3- thru 24-Position**  
**641440-1**  
See Note 1



**Two-Position Only**  
**641533-1**

No. of Pos.	Dim. A
3	.736 18.69
4	.892 22.66
6	1.204 30.58
9	1.672 42.47
12	2.140 54.36
15	2.608 66.24
24	4.012 101.9



**Recommended Panel Cutout**  
(Recommended Panel Thickness .062 [1.57] to .067 [1.70] max.)

MTA-156  
.156 [3.96]

## MTA-156 Posted Connector/Connector Mateability Guide

### Matrix for Tin Plated Part Numbers

This matrix has been prepared to assist you, our customer, in defining the correct mating halves for the MTA-156 posted connector and connector combination. Where a "Y" is indicated the combination is a valid mating pair. Where an "N" is indicated the combination is not acceptable for mating.

Connectors	Posted Connectors									
	641436	641436	641437	641438	641439	641522	641523	641524	641525	641526
640426	Y	Y	Y	Y	Y	Y	Y	Y	Y	Y
640427	Y	Y	Y	Y	Y	Y	Y	Y	Y	Y
640428	Y	Y	Y	Y	Y	Y	Y	Y	Y	Y
640429	Y	Y	Y	Y	Y	Y	Y	Y	Y	Y
640430	Y	Y	Y	Y	Y	Y	Y	Y	Y	Y
640431	N	N	N	N	N	N	N	N	N	N
640432	N	N	N	N	N	N	N	N	N	N
640433	N	N	N	N	N	N	N	N	N	N
640434	N	N	N	N	N	N	N	N	N	N
640435	N	N	N	N	N	N	N	N	N	N
640472	Y	Y	Y	Y	Y	Y	Y	Y	Y	Y
640473	Y	Y	Y	Y	Y	Y	Y	Y	Y	Y
640474	Y	Y	Y	Y	Y	Y	Y	Y	Y	Y
640475	Y	Y	Y	Y	Y	Y	Y	Y	Y	Y
640476	Y	Y	Y	Y	Y	Y	Y	Y	Y	Y
640477	N	N	N	N	N	N	N	N	N	N
640478	N	N	N	N	N	N	N	N	N	N
640479	N	N	N	N	N	N	N	N	N	N
640480	N	N	N	N	N	N	N	N	N	N
640481	N	N	N	N	N	N	N	N	N	N
640595	Y	Y	Y	Y	Y	Y	Y	Y	Y	Y
640599	Y	Y	Y	Y	Y	Y	Y	Y	Y	Y
640600	Y	Y	Y	Y	Y	Y	Y	Y	Y	Y
640601	Y	Y	Y	Y	Y	Y	Y	Y	Y	Y
640602	Y	Y	Y	Y	Y	Y	Y	Y	Y	Y
640604	N	N	N	N	N	N	N	N	N	N
640605	N	N	N	N	N	N	N	N	N	N
640606	N	N	N	N	N	N	N	N	N	N
640607	N	N	N	N	N	N	N	N	N	N
640608	N	N	N	N	N	N	N	N	N	N
641301	Y	Y	Y	Y	Y	Y	Y	Y	Y	Y
641302	Y	Y	Y	Y	Y	Y	Y	Y	Y	Y
641303	Y	Y	Y	Y	Y	Y	Y	Y	Y	Y
641304	Y	Y	Y	Y	Y	Y	Y	Y	Y	Y
641305	Y	Y	Y	Y	Y	Y	Y	Y	Y	Y
641306	N	N	N	N	N	N	N	N	N	N
641307	N	N	N	N	N	N	N	N	N	N
641308	N	N	N	N	N	N	N	N	N	N
641309	N	N	N	N	N	N	N	N	N	N
641310	N	N	N	N	N	N	N	N	N	N
643817	N	N	N	N	N	N	N	N	N	N
643818	N	N	N	N	N	N	N	N	N	N
643819	N	N	N	N	N	N	N	N	N	N
643820	N	N	N	N	N	N	N	N	N	N
643821	N	N	N	N	N	N	N	N	N	N
644082	N	N	N	N	N	N	N	N	N	N
644461	N	N	N	N	N	N	N	N	N	N
644462	N	N	N	N	N	N	N	N	N	N
644463	N	N	N	N	N	N	N	N	N	N
644464	N	N	N	N	N	N	N	N	N	N
644465	N	N	N	N	N	N	N	N	N	N
644466	N	N	N	N	N	N	N	N	N	N
644467	N	N	N	N	N	N	N	N	N	N
644468	N	N	N	N	N	N	N	N	N	N
644469	N	N	N	N	N	N	N	N	N	N
644470	N	N	N	N	N	N	N	N	N	N
644471	N	N	N	N	N	N	N	N	N	N
644472	N	N	N	N	N	N	N	N	N	N
644501	N	N	N	N	N	N	N	N	N	N
644502	N	N	N	N	N	N	N	N	N	N
644566	N	N	N	N	N	N	N	N	N	N
644567	N	N	N	N	N	N	N	N	N	N
644569	N	N	N	N	N	N	N	N	N	N
644570	N	N	N	N	N	N	N	N	N	N
644572	N	N	N	N	N	N	N	N	N	N
644783	N	N	N	N	N	N	N	N	N	N
644791	N	N	N	N	N	N	N	N	N	N
644860	Y	Y	Y	Y	Y	Y	Y	Y	Y	Y
644878	N	N	N	N	N	N	N	N	N	N

### MTA-156 Posted Connector/Connector Mateability Guide (Continued)

This matrix has been prepared to assist you, our customer, in defining the correct mating halves for the MTA-156 posted connector and connector combination. Where a "Y" is indicated the combination is a valid mating pair. Where an "N" is indicated the combination is not acceptable for mating.

**Matrix for .000030  
[0.00076] Gold Plated  
Part Numbers**

**Posted Connectors**

	644807	644809	644812	644814
641217	Y	Y	Y	Y
641218	Y	Y	Y	Y
641219	Y	Y	Y	Y
641220	Y	Y	Y	Y
641221	Y	Y	Y	Y
641222	N	N	N	N
641223	N	N	N	N
641224	N	N	N	N
641225	N	N	N	N
641226	N	N	N	N
641227	Y	Y	Y	Y
641228	Y	Y	Y	Y
641229	Y	Y	Y	Y
641230	Y	Y	Y	Y
641231	Y	Y	Y	Y
641232	N	N	N	N
641233	N	N	N	N
641234	N	N	N	N
641235	N	N	N	N
641236	N	N	N	N
644460	N	N	N	N
644662	N	N	N	N
644663	N	N	N	N
644687	N	N	N	N
644718	N	N	N	N
644720	N	N	N	N

Connectors

**Matrix for .000015  
[0.00038] Gold Plated  
Part Numbers**

**Posted Connectors**

	643895	647476	647481	647497
641148	Y	Y	Y	Y
641149	Y	Y	Y	Y
641150	Y	Y	Y	Y
641151	Y	Y	Y	Y
641152	Y	Y	Y	Y
641153	N	N	N	N
641154	N	N	N	N
641155	N	N	N	N
641156	N	N	N	N
641157	N	N	N	N
641168	Y	Y	Y	Y
641169	Y	Y	Y	Y
641170	Y	Y	Y	Y
641171	Y	Y	Y	Y
641172	Y	Y	Y	Y
641173	N	N	N	N
641174	N	N	N	N
641175	N	N	N	N
641176	N	N	N	N
641177	N	N	N	N
644284	N	N	N	N
647478	N	N	N	N
647479	N	N	N	N
647496	N	N	N	N

Connectors

MTA-156  
.156 [3.96]

**MTA-156 IDC Posted Connectors (Wire-to-Wire)—Closed End, Feed-Thru**

**Material and Finish**

**Housing** — UL 94V-2 rated, nylon, see chart for color

**Contacts** — Copper alloy, post tin or .000030 [.00076] gold plated over nickel



**Notes:**

1. Mating half visuals - pages 36 thru 39.
2. Strain relief & dust covers - pages 40 & 41.
3. Approved wire listing - page 70.

**Connector Ordering Information**

The "Base Part Numbers" Chart at right shows the base part number and number of circuits available for the described connectors.

Prefixes and suffixes are determined by the number of circuit positions in the connector. For example, the complete part number for a 12-position closed end connector for 18 AWG wire would be:

Base number **641435** plus prefix-and-suffix **4- -2**

The correct ordering number is **4-641435-2**

See page 15 for an explanation of RoHS lead free equivalents.

**Note:** All RoHS equivalent part numbers may not be available upon catalog release. If the number you need is not available, please contact Product Engineering to expedite your request.

**Color Coding by Wire Size for UL 94V-2 Connectors**

- 18 AWG — Orange
- 20 AWG — Yellow
- 22 AWG — Red
- 24 AWG — White
- 26 AWG — Blue

**Performance Data**

**Voltage Rating** — 600 VAC

**Current Rating** — 7 amp max.

**Low-Level Resistance** — 7 mΩ max. initial

**Dielectric Withstanding Voltage** — 1500 VAC/1 min.

**Insulation Resistance** — 5000 MΩ min. initial

**Operating Temperature** — -55° C to +105° C

**Base Part Numbers**

Connector Type & Wire Size	Closed End Connector <sup>1</sup>		Feed-Thru Connector <sup>1</sup>	
	Part Nos.	RoHS Equiv.	Part Nos.	RoHS Equiv.
<b>Standard UL 94V-2, Tin Plated</b>				
18 AWG 0.8-0.9 mm <sup>2</sup>	641435	32, 33, 34, 36, 39, 42, 45, 54	641522	32, 33, 34, 36, 39, 42, 45, 54
20 AWG 0.5-0.6 mm <sup>2</sup>	641436	32, 33, 34, 36, 39, 42, 45, 54	641523	32, 33, 34, 36, 39, 42, 45, 54
22 AWG 0.3-0.4 mm <sup>2</sup>	641437	32, 33, 34, 36, 39, 42, 45, 54	641524	32, 33, 34, 36, 39, 42, 45, 54
24 AWG 0.2 mm <sup>2</sup>	641438	32, 33, 34, 36, 39, 42, 45, 54	641525	32, 33, 34, 36, 39, 42, 45, 54
26 AWG 0.12-0.15 mm <sup>2</sup>	641439	32, 33, 34, 36, 39, 42, 45, 54	641526	32, 33, 34, 36, 39, 42, 45, 54
<b>Standard UL 94V-2, .000030 [0.00076] Gold Plated</b>				
18 AWG 0.8-0.9 mm <sup>2</sup>	644807	32, 33, 34, 36, 39, 42, 45, 54	644812	32, 33, 34, 36, 39, 42, 45, 54
20 AWG 0.5-0.6 mm <sup>2</sup>	— <sup>2</sup>	—	— <sup>2</sup>	—
22 AWG 0.3-0.4 mm <sup>2</sup>	644809	32, 33, 34, 36, 39, 42, 45, 54	644814	32, 33, 34, 36, 39, 42, 45, 54
24 AWG 0.2 mm <sup>2</sup>	— <sup>2</sup>	—	— <sup>2</sup>	—
26 AWG 0.12-0.15 mm <sup>2</sup>	— <sup>2</sup>	—	— <sup>2</sup>	—
<b>Standard UL 94V-2, .000015 [0.00038] Gold Plated</b>				
18 AWG 0.8-0.9 mm <sup>2</sup>	647476	32, 33, 34, 36, 39, 42, 45, 54	647481	32, 33, 34, 36, 39, 42, 45, 54
22 AWG 0.3-0.4 mm <sup>2</sup>	643995	32, 33, 34, 36, 39, 42, 45, 54	647497	32, 33, 34, 36, 39, 42, 45, 54

<sup>1</sup> MTA-156 Posted Connectors (Closed End and Feed-Thru) will **Only mate** with MTA-156 connectors with locking ramp and without polarizing tabs. They **will NOT mate** with MTA-156 Quad Connectors.

<sup>2</sup> Parts can be made available upon request. Minimums may apply.

No. of Circuits	Dim.		Suffix	No. of Circuits	Dim.		Prefix/Suffix
	A	B			A	B	
2	.468 11.89	.316 8.03	-2	9	1.560 39.62	1.408 35.76	-9
3	.624 15.85	.472 11.99	-3	12	2.028 51.51	1.876 47.65	1- -2
4	.780 19.81	.628 15.95	-4	15	2.496 63.40	2.344 59.54	1- -5
6	1.092 27.74	.940 23.88	-6	24	3.900 99.06	3.748 95.20	2- -4

**Technical Documents**

**Product Specification**  
108-1065 MTA-156 Posted Connector

**Application Specification**  
114-1020 MTA-156 Connectors, Posted Connectors and Card Edge Connectors

**Replacement IDC Contacts**

**Material and Finish**

**Contacts** — Copper alloy, post tin plated over nickel



AWG	Wire Size		Part Numbers
	mm <sup>2</sup>		
18	0.8-0.9		3-641425-1
20	0.5-0.6		3-641426-1
22	0.3-0.4		3-641427-1
24	0.2		3-641428-1
26	0.12-0.15		3-641429-1

## MTA-156 Flat Headers—Straight

### Material and Finish

**Housing**—UL94V-0 rated, polyester, white

**Posts**—Copper alloy, tin plated, .000030 [0.00076] or .000015 [0.00038] gold over nickel

**Notes:**

1. Post(s) can be omitted for keying purposes. Specify the desired post(s) to be omitted using the figure to identify Post No. 1.
2. Gold headers are duplex plated, gold on mating end of post and tin on the solder tail.
3. .125 [3.18] solder tail lengths are for .062 [1.57] thick printed circuit boards and .175 [4.45] solder tail lengths are for .093-.125 [2.36-3.18] thick printed circuit boards.
4. To determine header overall length (Dim. A), multiply .156 x the number of posts. Example: .156 x 10 posts equals 1.560 inches [39.62 mm].

For mateability options, see matrix on pages 34, 35, 54 and 58.

For mating half visuals, see pages 36 thru 39, 55, 60 and 62.



Recommended Mounting Hole Pattern for .062 [1.57] Thk. PC Board

PC Board Hole Diameters	
Square Post	Round Post
.080/.070 [2.03/1.78]	.070/.060 [1.78/1.52]

### Header Ordering Information

The "Base Part Numbers" Chart at right shows the base part number and number of posts available for the described headers.

Prefixes and suffixes are determined by the number of post positions in the header. For example, the complete part number for a 10-position header with square posts and a .125 [3.18] solder tail length would be:

Base number **640383** plus prefix-and-suffix **4- -0**

The correct ordering number is **4-640383-0**

The part numbers in **bold face** are the RoHS equivalent version. Example:

No. of Pos.	Lead Free RoHS Prefix/Suffix
2	3-640383-2
	thru
24	5-640383-4

See page 15 for an explanation of RoHS lead free equivalents.

**Note:** All RoHS equivalent part numbers may not be available upon catalog release. If the number you need is not available, please contact Product Engineering to expedite your request.

**Note:** Consult Product Drawing for details on placing headers onto PC boards.

### Base Part Numbers

Square Posts				Round Posts			
.125 [3.18] Solder tail		.175 [4.45] Solder tail		.125 [3.18] Solder tail		.175 [4.45] Solder tail	
Header Part Nos.	RoHS Equiv.	Header Part Nos.	RoHS Equiv.	Header Part Nos.	RoHS Equiv.	Header Part Nos.	RoHS Equiv.
<b>Standard UL94V-0, Tin Plated</b>							
640383	2-24	644749	2-24	640384	2-24	644750	2-24
<b>Standard UL94V-0, .000030 [0.00076] Gold Plated</b>							
641202	32-54	644756	32-54	641203	32-54	644757	32-54
<b>Standard UL94V-0, .000015 [0.00038] Gold Plated</b>							
641113	32-54	644763	32-54	641114	32-54	644764	32-54

**Note:** Select load headers (omitted pin headers) are available upon request. Please contact product engineer or product manager for details.

MTA-156  
.156 [3.96]

**MTA-156 Flat Headers—Right-Angle**

**Material and Finish**

**Housing**—UL94V-0 rated, polyester, white

**Posts**—Copper alloy, tin plated, .000030 [0.00076] or .000015 [0.00038] gold over nickel

**Notes:**

1. Post(s) can be omitted for keying purposes. Specify the desired post(s) to be omitted using the figure to identify Post No. 1.
2. Gold headers are duplex plated, gold on mating end of post and tin on the solder tail.
3. .125 [3.18] solder tail lengths are for .062 [1.57] thick printed circuit boards and .175 [4.45] solder tail lengths are for .093-.125 [2.36-3.18] thick printed circuit boards.
4. To determine header overall length (Dim. A), multiply .156 x the number of posts. Example: .156 x 10 posts equals 1.560 inches [39.62 mm].

For mateability options, see matrix on pages 34, 35, 54 and 58.

For mating half visuals, see pages 36 thru 39, 55, 60 and 62.

**Header Ordering Information**

The "Base Part Numbers" Chart at right shows the base part number and number of posts available for the described headers.

Prefixes and suffixes are determined by the number of post positions in the header. For example, the complete part number for a 10-position header with square posts and a .125 [3.18] solder tail length would be:

Base number **641204** plus prefix-and-suffix **4- -0**

The correct ordering number is **4-641204-0**

The part numbers in **bold face** are the RoHS equivalent version. Example:

No. of Pos.	Lead Free RoHS Prefix/Suffix
2	3-641204-2
	thru
24	5-641204-4

See page 15 for an explanation of RoHS lead free equivalents.

**Note:** All RoHS equivalent part numbers may not be available upon catalog release. If the number you need is not available, please contact Product Engineering to expedite your request.



**Recommended Mounting Hole Pattern for .062 [1.57] Thk. PC Board**

X = .140 [3.56] Min., .430 [10.92] Max. when mated with MTA Connector.  
 X = .140 [3.56] Min. when mated with SL-156 Wire-to-Board Connector.

**Note:** Consult Product Drawing for details on placing headers onto PC boards.



**Recommended Mounting Hole Pattern for .063 [1.60] Thk. PC Board for Retentive Leg Header**  
 Y = .140 [3.56] Min., .430 [10.92] Max. when mated with MTA Connector.

**Base Part Numbers**

Retentive Leg		Square Posts		.175 [4.45] Solder tail	
Header Part Nos.	RoHS Equiv.	Header Part Nos.	RoHS Equiv.	Header Part Nos.	RoHS Equiv.
<b>Standard UL94V-0, Tin Plated</b>					
647646	2-12	640385	2-24	644751	2-24
<b>Standard UL94V-0, .000030 [0.00076] Gold Plated</b>					
—	—	641204	32-54	644758	32-54
<b>Standard UL94V-0, .000015 [0.00038] Gold Plated</b>					
—	—	641115	32-54	644765	32-54

**Note:** Select load headers (omitted pin headers) are available upon request. Please contact product engineer or product manager for details.

## MTA-156 Friction Lock Headers—Straight

### Material and Finish

**Housing**—UL94V-0 rated, polyester, white

**Posts**—Copper alloy, tin plated, .000030 [0.00076] or .000015 [0.00038] gold over nickel

**Notes:**

1. Post(s) can be omitted for keying purposes. Specify the desired post(s) to be omitted using the figure to identify Post No. 1.
2. Gold headers are duplex plated, gold on mating end of post and tin on the solder tail.
3. .125 [3.18] solder tail lengths are for .062 [1.57] thick printed circuit boards and .175 [4.45] solder tail lengths are for .093-.125 [2.36-3.18] thick printed circuit boards.
4. To determine header overall length (Dim. A), multiply .156 x the number of posts. Example: .156 x 10 posts equals 1.560 inches [39.62 mm].

For mateability options, see matrix on pages 34, 35, 54 and 58.

For mating half visuals, use connectors with a locking ramp for polarization/retention purposes, see pages 36 thru 39, 55, 60 and 62.

For polarizing purposes only use connectors without a locking ramp. See pages 36 thru 39, 55, 60 and 62.

### Header Ordering Information

The "Base Part Numbers" Chart at right shows the base part number and number of posts available for the described headers.

Prefixes and suffixes are determined by the number of post positions in the header. For example, the complete part number for a 10-position header with square posts and a .125 [3.18] solder tail length would be: Base number **641208** plus prefix-and-suffix **4- -0**

The correct ordering number is **4-641208-0**

The part numbers in **bold face** are the RoHS equivalent version. Example:

No. of Pos.	Standard Prefix/Suffix	Lead Free RoHS Prefix/Suffix
2	641208-2	3-641208-2
	thru	
24	2-641208-4	5-641208-4

See page 15 for an explanation of RoHS lead free equivalents.



Y = .068 [1.73] Max. 2-8 position tin plated and 2-24 position gold plated headers.

Y = .073 [1.85] 9-24 position tin plated headers.



Recommended Mounting Hole Pattern for .062 [1.57] Thk. PC Board

PC Board Hole Diameters	
Square Post	Round Post
.080/.070 [2.03/1.78]	.070/.060 [1.78/1.52]



**Note:** Consult Product Drawing for details on placing headers onto PC boards.

### Base Part Numbers

		Square Posts				Round Posts			
		.125 [3.18] Solder tail		.175 [4.45] Solder tail		.125 [3.18] Solder tail		.175 [4.45] Solder tail	
Header Part Nos.	RoHS Equiv.	Header Part Nos.	RoHS Equiv.	Header Part Nos.	RoHS Equiv.	Header Part Nos.	RoHS Equiv.	Header Part Nos.	RoHS Equiv.
<b>Standard UL94V-0, Tin Plated</b>									
1744017	<b>2-12</b>	640445	<b>2-24</b>	644752	<b>2-24</b>	640388	<b>2-24</b>	644753	<b>2-24</b>
<b>Standard UL94V-0, .000030 [0.00076] Gold Plated</b>									
—	—	641208	<b>32-54</b>	644759	<b>32-54</b>	641209	<b>32-54</b>	644760	<b>32-54</b>
<b>Standard UL94V-0, .000015 [0.00038] Gold Plated</b>									
—	—	641119	<b>32-54</b>	644766	<b>32-54</b>	641120	<b>32-54</b>	644767	<b>32-54</b>

**Note:** All RoHS equivalent part numbers may not be available upon catalog release. If the number you need is not available, please contact Product Engineering to expedite your request.

**Note:**

Select load headers (omitted pin headers) and tube loaded product are available upon request. Please contact product engineer or product manager for details.

MTA-156  
.156 [3.96]



## MTA-156 Friction Lock Headers—Right-Angle

### Material and Finish

**Housing** — UL94V-0 rated, polyester, white

**Posts** — Copper alloy, tin plated, .000030 [0.00076] or .000015 [0.00038] gold over nickel

**Notes:**

1. Post(s) can be omitted for keying purposes. Specify the desired post(s) to be omitted using the figure to identify Post No. 1.
2. Gold headers are duplex plated, gold on mating end of post and tin on the solder tail.
3. .125 [3.18] solder tail lengths are for .062 [1.57] thick printed circuit boards and .175 [4.45] solder tail lengths are for .093-.125 [2.36-3.18] thick printed circuit boards.
4. To determine header overall length (Dim. A), multiply .156 x the number of posts. Example: .156 x 10 posts equals 1.560 inches [39.62 mm].

For mateability options, see matrix on pages 34, 35, 54 and 58.

When using Front Bend Headers—for mating half visuals use connectors with a locking ramp for polarization/retention purposes. When using Rear Bend Headers—for mating half visuals use connectors without a locking ramp. For polarization purposes only see pages 36 thru 39, 55, 60 and 62.



Recommended Mounting Hole Pattern for .062 [1.57] Thk. PC Board

Y = .068 [1.73] Max. 2-8 position tin plated and 2-24 position gold plated headers.

Y = .073 [1.85] 9-24 position tin plated headers.



**Front Bend**  
 X = .325 [8.26] Min., .400 [10.16] Max., when mated with MTA Connector.  
 X = .325 [8.26] Min., .345 [8.76] Max., when mated with SL-156 Connector.

**Rear Bend**  
 X = .500 [12.7] Min., .650 [16.51] Max., when mated with MTA Connector.  
 X = .500 [12.7] Min., when mated with SL-156 Connector.

### Header Ordering Information

The "Base Part Numbers" Chart at right shows the base part number and number of posts available for the described headers.

Prefixes and suffixes are determined by the number of post positions in the header. For example, the complete part number for a 10-position header with square posts, front bend, and a .125 [3.18] solder tail length would be:

Base number **641210** plus prefix-and-suffix **4- -0**

The correct ordering number is **4-641210-0**

The part numbers in **bold face** are the RoHS equivalent version. Example:

No. of Pos.	Standard Prefix/Suffix	Lead Free RoHS Prefix/Suffix
2	641210-2	3-641210-2
	thru	
24	2-641210-4	5-641210-4

See page 15 for an explanation of RoHS lead free equivalents.

Note: Consult Product Drawing for details on placing headers onto PC boards.

### Base Part Numbers

Square Posts							
Front Bend				Rear Bend			
.125 [3.18] Solder tail		.175 [4.45] Solder tail		.125 [3.18] Solder tail		.175 [4.45] Solder tail	
Header Part Nos.	RoHS Equiv.	Header Part Nos.	RoHS Equiv.	Header Part Nos.	RoHS Equiv.	Header Part Nos.	RoHS Equiv.
<b>Standard UL94V-0, Tin Plated</b>							
640389	2-24	644754	2-24	640387	2-24	644755	2-24
<b>Standard UL94V-0, .000030 [0.00076] Gold Plated</b>							
641210	32-54	644761	32-54	641207	32-54	644762	32-54
<b>Standard UL94V-0, .000015 [0.00038] Gold Plated</b>							
641121	32-54	644768	32-54	641118	32-54	644769	32-54

Note: All RoHS equivalent part numbers may not be available upon catalog release. If the number you need is not available, please contact Product Engineering to expedite your request.

Note: Select lead headers (omitted pin headers) are available upon request. Please contact product engineer or product manager for details.

**MTA-156 Polarized Lock Headers—Straight**

**Material and Finish**

**Housing** — UL94V-0 rated, polyester, white

**Posts** — Copper alloy, tin plated or .000030 [0.00076] gold over nickel

**Notes:**

1. Post(s) can be omitted for keying purposes. Specify the desired post(s) to be omitted using the figure to identify Post No. 1.
2. Peg holes are not required in PC Boards when headers without pegs are used.
3. One peg only on a 2 position header, other position sizes have two pegs.
4. Headers with .00015 [0.00038] gold plated post are available upon request. Minimums may apply.
5. To determine header overall length (Dim. A), multiply .156 x the number of posts. Example: .156 x 10 posts equals 1.560 inches [39.62 mm].

For mateability options, see matrix on pages 34, 35, 54 and 58.

For mating half visuals, use connectors with a locking ramp for polarization/retention purposes, see pages 36 thru 39, 55, 60 and 62.

For polarizing purposes only use connectors without a locking ramp. See pages 36 thru 39, 60 and 62.



PC Board Hole Diameters	
Square Post	Round Post
.069/.065 [1.75/1.65]	.054/.050 [1.37/1.27]

Recommended Mounting Hole Pattern for .062 [1.57] Thk. PC Board

**Note:** Consult Product Drawing for details on placing headers onto PC boards.

**Header Ordering Information**

The "Base Part Numbers" Chart at right shows the base part number and number of posts available for the described headers.

Prefixes and suffixes are determined by the number of post positions in the header. For example, the complete part number for a 10-position header with square posts with pegs would be:

Base number **644615** plus prefix-and-suffix **4- -0**

The correct ordering number is **4-644615-0**

The part numbers in **bold face** are the RoHS equivalent version. Example:

No. of Pos.	Lead Free RoHS Prefix/Suffix
2	3-644615-2
	thru
18	4-644615-8

See page 15 for an explanation of RoHS lead free equivalents.

**Base Part Numbers**

Square Posts				Round Posts			
Without Pegs		With Pegs		Without Pegs		With Pegs	
Header Part Nos.	RoHS Equiv.	Header Part Nos.	RoHS Equiv.	Header Part Nos.	RoHS Equiv.	Header Part Nos.	RoHS Equiv.
<b>Standard UL94V-0, Tin Plated</b>							
644611	<b>32-48</b>	644615	<b>32-48</b>	644612	<b>32-48</b>	644616	<b>32-48</b>
<b>Standard UL94V-0, .000030 [0.00076] Gold Plated</b>							
644627	<b>32-48</b>	644631	<b>32-48</b>	644628	<b>32-48</b>	644632	<b>32-48</b>

**Note:** All RoHS equivalent part numbers may not be available upon catalog release. If the number you need is not available, please contact Product Engineering to expedite your request.

**Note:** Select load headers (omitted pin headers) are available upon request. Please contact product engineer or product manager for details.

MTA-156  
.156 [3.96]

**MTA-156 Polarized Lock Headers—Right-Angle**

**Material and Finish**

**Housing**—UL94V-0 rated, polyester, white

**Posts**—Copper alloy, tin plated or .000030 [0.00076] gold over nickel

**Notes:**

1. Post(s) can be omitted for keying purposes. Specify the desired post(s) to be omitted using the figure to identify Post No. 1.
2. Peg holes are not required in PC Boards when headers without pegs are used.
3. One peg only on a 2 position header, other position sizes have two pegs.
4. Headers with .00015 [0.00038] gold plated post are available upon request. Minimums may apply.
5. To determine header overall length (Dim. A), multiply .156 x the number of posts. Example: .156 x 10 posts equals 1.560 inches [39.62 mm].

For mateability options, see matrix on pages 34, 35, 54 and 58.

For mating half visuals, use only connectors with a locking ramp for polarization/retention purposes, see pages 36 thru 39, 55, 60 and 62.

For polarizing purposes only use connectors without a locking ramp. See pages 36 thru 39, 60 and 62.



**Recommended Mounting Hole Pattern for .062 [1.57] Thk. PC Board**

**Note:** Consult Product Drawing for details on placing headers onto PC boards.

**Header Ordering Information**

The “Base Part Numbers” Chart at right shows the base part number and number of posts available for the described headers.

Prefixes and suffixes are determined by the number of post positions in the header. For example, the complete part number for a 10-position header with front bend and with pegs would be:

Base number **644617** plus prefix-and-suffix **4- -0**

The correct ordering number is **4-644617-0**

The part numbers in **bold face** are the RoHS equivalent version. Example:

No. of Pos.	Lead Free RoHS Prefix/Suffix
2	<b>3-644617-2</b>
	thru
18	<b>4-644617-8</b>

See page 15 for an explanation of RoHS lead free equivalents.

**Base Part Numbers**

Square Posts					
Front Bend				Rear Bend	
Without Pegs		With Pegs		Without Pegs	
Header Part Nos.	RoHS Equiv.	Header Part Nos.	RoHS Equiv.	Header Part Nos.	RoHS Equiv.
<b>Standard UL94V-0, Tin Plated</b>					
644613	<b>32-48</b>	644617	<b>32-48</b>	644614	<b>32-48</b>
<b>Standard UL94V-0, .000030 [0.00076] Gold Plated</b>					
644629	<b>32-48</b>	644633	<b>32-48</b>	644630	<b>32-48</b>

**Note:** All RoHS equivalent part numbers may not be available upon catalog release. If the number you need is not available, please contact Product Engineering to expedite your request.

**Note:** Select load headers (omitted pin headers) are available upon request. Please contact product engineer or product manager for details.

MTA-156  
.156 [3.96]

## MTA-156 Friction Lock High Temperature Headers—Straight

### Material and Finish

**Housing** — UL94V-0 rated, nylon, black

**Posts** — Copper alloy, tin plated, .000015 [0.00038] gold over nickel

**Temperature** — Maximum Temperature Rating: 280°C

**Notes:**

1. Post(s) can be omitted for keying purposes. Specify the desired post(s) to be omitted using the figure to identify Post No. 1.
2. Gold headers are duplex plated, gold on mating end of post and tin-lead on the solder tail.
3. Headers with straight and right-angle square posts are available upon request. Minimums may apply.
4. To determine header overall length (Dim. A), multiply .156 x the number of posts. Example: .156 x 10 posts equals 1.560 inches [39.62 mm].

For mateability options, see matrix on pages 34, 35, 54 and 58.

For mating half visuals, use connectors with a locking ramp for polarization/retention purposes, see pages 36 thru 39, 55, 60 and 62.

For polarizing purposes only use connectors without a locking ramp. See pages 36 thru 39, 60 and 62.

### Header Ordering Information

The "Base Part Numbers" Chart at right shows the base part number and number of posts available for the described headers.

Prefixes and suffixes are determined by the number of post positions in the header. For example, the complete part number for a 10-position header with round tin plated posts:

Base number **647648** plus prefix-and-suffix **4- -0**

The correct ordering number is **4-647648-0**

The part numbers in **bold face** are the RoHS equivalent version. Example:

No. of Pos.	Lead Free RoHS Prefix/Suffix
2	3-647648-2
12	4-647648-2

See page 15 for an explanation of RoHS lead free equivalents.

**Note:** All RoHS equivalent part numbers may not be available upon catalog release. If the number you need is not available, please contact Product Engineering to expedite your request.

### For use with Infrared Reflow Process



**Recommended Mounting Hole Pattern for .062 [1.57] Thick PC Board**

**Note:** Consult Product Drawing for details on placing headers onto PC boards.

### Base Part Numbers

Round Post		
Header Part Nos.		RoHS Equiv.
<b>Standard UL94V-0, Tin Plated</b>		
647648		<b>32-42</b>
<b>Standard UL94V-0, .000015 [0.00038] Gold Plated</b>		
647649		<b>32-42</b>

**Note:**

Select load headers (omitted pin headers) are available upon request. Please contact product engineer or product manager for details.

MTA-156  
.156 [3.96]

## MTA-156 Shrouded Headers—Straight and Right-Angle

### Material and Finish

**Housing**—UL94V-0 rated, polyester, black

**Posts**—Copper alloy, tin plated; or .000030 [0.00076] or .000015 [0.00038] gold over nickel

#### Notes:

1. Post(s) can be omitted for keying purposes. Specify the desired post(s) to be omitted using the figure to identify Post No. 1.
2. Gold headers are duplex plated, gold on mating end of post and tin on the solder tail.
3. Peg holes are not required in PC boards when headers without pegs are used.
4. One peg only on a 2 position header, other position sizes have two pegs.
5. Right-angle front and rear bend headers with retention pegs can be made available upon request. Minimums may apply.

For mateability options, see matrix on pages 34, 35, 54 and 58.

For mating half visuals, see pages 36 thru 39 and 55.

### Header Ordering Information

The “Base Part Numbers” Chart at right shows the base part number and number of posts available for the described headers.

Prefixes and suffixes are determined by the number of post positions in the header. For example, the complete part number for a 10-position header with straight, square posts and with pegs would be: Base number **647127** plus prefix-and-suffix **4- -0**

The correct ordering number is **4-647127-0**

No. of Pos.	Dim. A	RoHS Prefix/Suffix
2	.406 10.31	2--2
3	.562 14.27	2--3
4	.718 18.24	2--4
5	.874 22.20	2--5
6	1.030 26.16	2--6
7	1.186 30.12	2--7
8	1.342 34.09	2--8
9	1.498 38.05	2--9
10	1.654 42.01	3--0
11	1.810 45.97	3--1
12	1.966 49.94	3--2

**Note:** All RoHS equivalent part numbers may not be available upon catalog release. If the number you need is not available, please contact Product Engineering to expedite your request.

### Straight Post (.045 [1.14] Square or Round)



### PC Board Hole Diameters

Square Post	Round Post
.069/.065 [1.75/1.65]	.054/.050 [1.37/1.27]

**Note:** Consult Product Drawing for details on placing headers onto PC boards.

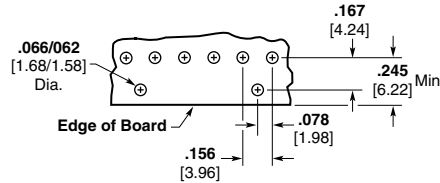

Recommended Mounting Hole Pattern for .062 [1.57] Thick PC Board Using a Straight Post Header

### Right-Angle (.045 [1.14] Square)

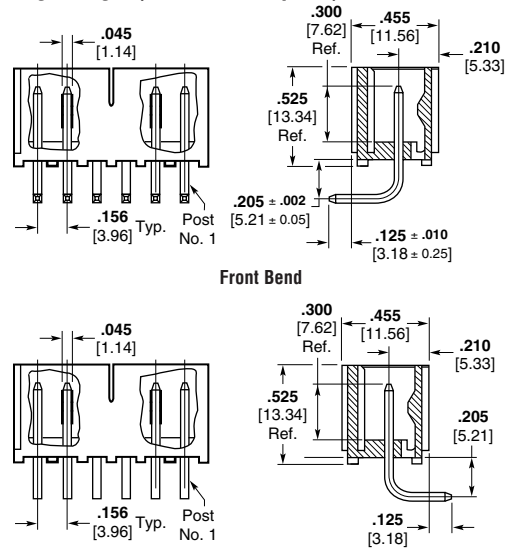

Recommended Mounting Hole Pattern for .062 [1.57] Thick PC Board Using a Right-Angle Header

### Base Part Numbers

Straight Square Posts				Straight Round Posts			
Without Pegs		With Pegs		Without Pegs		With Pegs	
Header Part Nos.	RoHS Equiv.	Header Part Nos.	RoHS Equiv.	Header Part Nos.	RoHS Equiv.	Header Part Nos.	RoHS Equiv.
<b>Standard UL94V-0, Tin Plated</b>							
647123	22-32	647127	22-32	647124	22-32	647128	22-32
<b>Standard UL94V-0, .000030 [0.00076] Gold Plated</b>							
647131	22-32	647135	22-32	647132	22-32	647136	22-32
<b>Standard UL94V-0, .000015 [0.00038] Gold Plated</b>							
647139	22-32	647143	22-32	647140	22-32	647144	22-32
<b>Square Posts</b>							
Right-Angle Posts, Front Bend Without Pegs				Right-Angle Posts, Rear Bend Without Pegs			
Header Part Nos.		RoHS Equiv.		Header Part Nos.		RoHS Equiv.	
<b>Standard UL94V-0, Tin Plated</b>							
647125		22-32		647126		22-32	
<b>Standard UL94V-0, .000030 [0.00076] Gold Plated</b>							
647133		22-32		647134		22-32	
<b>Standard UL94V-0, .000015 [0.00038] Gold Plated</b>							
647141		22-32		647142		22-32	

**Note:** Select load headers (omitted pin headers) are available upon request. Please contact product engineer or product manager for details.

**MTA-156 IDC Quad Connectors**

**Product Facts**

- Provides four points of contact
- Greater current carrying capability than Standard MTA-156 Connectors
- Connector styles include both closed end and feed-thru with locking ramp, with and without polarizing tabs in 2 through 12 positions
- Available for wire ranges of 18–22 AWG [0.9–0.3 mm<sup>2</sup>]
- Contacts are lubricated for fretting corrosion protection
- Complies with Tyco Electronics Quality Specification 102-6, “Preparation of Design Objectives”
- Uses existing MTA application tooling for termination
- Quad connectors preloaded with contacts
- All contacts are slotted for insulation displacement (IDC) termination technique
- Connectors and headers are end-to-end stackable
- AWG size is “frosted” on the side of the connector
- Recognized under the Component Program of Underwriters Laboratories Inc.,  File No. E28476
- Certified by Canadian Standards Association,  File No. LR 7189
- Satisfies the VDE requirements according to VDE 110, Insulation Group B, 250 vac for air and creepage paths

The MTA-156 Quad Connector provides a connection with four points of contact. The UL94V-0 rated connector with multi-point contacts provides greater current carrying capability than the Standard MTA-156 Connector. These connectors comply with Tyco Electronics Quality Specification 102-6\* and satisfy the VDE requirements according to VDE 110.

The connectors are available for wire ranges of 18–22 AWG [0.9–0.3 mm<sup>2</sup>] and in a variety of styles including closed end and feed-thru with locking ramp, with and without polarizing tabs.

Only one wire to be terminated into an IDC contact slot.

\*The 102-6 Quality Specification is the new procedure for “Preparation of Design Objectives”. Its purpose is to provide a means for verifying the maximum current carrying capacity of the device.

**Note:** Refer to pages 70 through 74 for approved wire listings.



**The MTA-156 Quad Connectors only mate with standard MTA-156 square post headers and use existing MTA application tooling for termination.**

**Performance Data**

- Voltage Rating** — 600 vac
- Current Rating** — 12.5 amp max. on a single circuit.
- For Multiple Circuit Loading** — refer to Product Specification for current rating chart.
- Low-Level Resistance** — 3.0 mΩ max. initial
- Dielectric Withstanding Voltage** — 1500 vac/1 min.
- Insulation Resistance** — 5000 MΩ min. initial
- Operating Temperature** — -55° C to +105° C

**Technical Documents**

**Product Specifications**

108-1219 MTA-156 Quad Connector System

**Application Specifications**

114-1048 MTA-156 Quad Connector

This matrix has been prepared to assist you, our customer, in defining the correct mating halves for the MTA-156 header and connector combination. Where a “Y” is indicated the combination is a valid mating pair.

**Headers**

	640383	640385	640389	640445	644611	644613	644615	644617	644749	644751	644752	644754	647123	647125	647126	647127
644329	Y	Y	Y	Y	Y	Y	Y	Y	Y	Y	Y	Y	Y	Y	Y	Y
644370	Y	Y	Y	Y	Y	Y	Y	Y	Y	Y	Y	Y	Y	Y	Y	Y
644371	Y	Y	Y	Y	Y	Y	Y	Y	Y	Y	Y	Y	Y	Y	Y	Y
644375	Y	Y	Y	Y	Y	Y	Y	Y	Y	Y	Y	Y	Y	Y	Y	Y
644376	Y	Y	Y	Y	Y	Y	Y	Y	Y	Y	Y	Y	Y	Y	Y	Y
644377	Y	Y	Y	Y	Y	Y	Y	Y	Y	Y	Y	Y	Y	Y	Y	Y
644381	Y	Y	Y	Y	Y	Y	Y	Y	Y	Y	Y	Y	Y	Y	Y	Y
644382	Y	Y	Y	Y	Y	Y	Y	Y	Y	Y	Y	Y	Y	Y	Y	Y
644383	Y	Y	Y	Y	Y	Y	Y	Y	Y	Y	Y	Y	Y	Y	Y	Y
644387	Y	Y	Y	Y	Y	Y	Y	Y	Y	Y	Y	Y	Y	Y	Y	Y
644388	Y	Y	Y	Y	Y	Y	Y	Y	Y	Y	Y	Y	Y	Y	Y	Y
644389	Y	Y	Y	Y	Y	Y	Y	Y	Y	Y	Y	Y	Y	Y	Y	Y

MTA-156 .156 [3.96]

## MTA-156 IDC Quad Connectors—Closed End and Feed-Thru

### Closed End with Locking Ramp

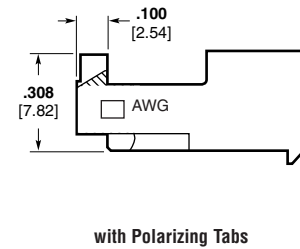
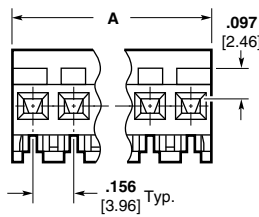

without Polarizing Tabs

with Polarizing Tabs

### Feed-Thru with Locking Ramp

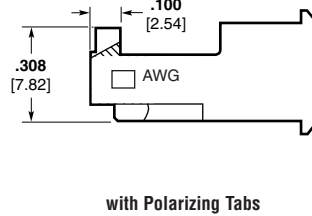
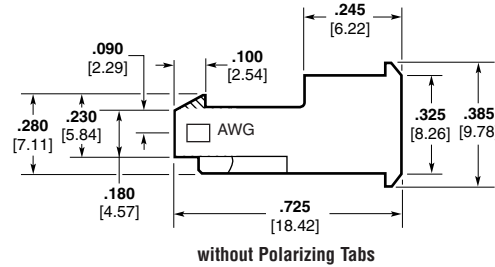
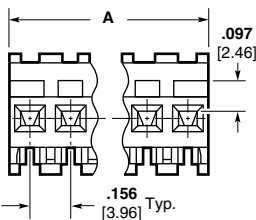

without Polarizing Tabs

with Polarizing Tabs

### Material and Finish

**Housing**—UL94V-0 rated, nylon, black

**Contacts**—High conductivity copper alloy, post tin plated

For mateability options, see matrix on page 54.

For strain relief and dust covers, see pages 40 and 41.

For mating half visuals, see pages 46 thru 48 and 50, 52 and 53, (49 and 51 Front Bend Headers only). **Mates with tin-plated square posts only.**

Refer to pages 70 thru 74 for approved wire listing.

**Note:** To determine connector overall length (Dim. A), multiply .156 x the number of circuits. Example: .156 x 10 circuits equals 1.560 inches [39.62 mm].

### Base Part Numbers

Connector Type & Wire Size	Closed End with Locking Ramp				Feed-Thru with Locking Ramp			
	Without Tabs		With Tabs		Without Tabs		With Tabs	
	Connector Part Nos.	RoHS Equiv.	Connector Part Nos.	RoHS Equiv.	Connector Part Nos.	RoHS Equiv.	Connector Part Nos.	RoHS Equiv.
<b>Standard UL94V-0, Tin Plated</b>								
<b>18 AWG</b> 0.8-0.9 mm <sup>2</sup>	644329	<b>32-42</b>	644381	<b>32-42</b>	644375	<b>32-42</b>	644387	<b>32-42</b>
<b>20 AWG</b> 0.5-0.6 mm <sup>2</sup>	644370	<b>32-42</b>	644382	<b>32-42</b>	644376	<b>32-42</b>	644388	<b>32-42</b>
<b>22 AWG</b> 0.3-0.4 mm <sup>2</sup>	644371	<b>32-42</b>	644383	<b>32-42</b>	644377	<b>32-42</b>	644389	<b>32-42</b>

### Connector Ordering Information

The "Base Part Numbers" Chart above shows the base part number and number of circuits available for the described connectors.

Prefixes and suffixes are determined by the number of circuit positions in the connector. For example, the complete part number for a 10-position closed end connector with locking ramp and without polarizing tabs for 18 AWG wire would be:

Base number **644329** plus  
prefix-and-suffix  
**1- -0**

The correct ordering number is  
**1-644329-0**

The set of numbers in **bold face** are the RoHS equivalent version of the standard product. Example:

No. of Pos.	Standard Prefix/Suffix	Lead Free RoHS Prefix/Suffix
2	644329-2	<b>3-644329-2</b>
thru		
12	1-644329-2	<b>4-644329-2</b>

See page 15 for an explanation of RoHS lead free equivalents.

**Note:** All RoHS equivalent part numbers may not be available upon catalog release. If the number you need is not available, please contact Product Engineering to expedite your request.

### Replacement IDC Contacts

#### Material and Finish

**Contacts**—High conductivity copper alloy post tin plated

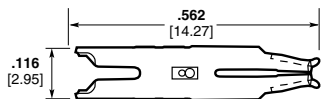

Wire Size		Part Numbers
AWG	mm <sup>2</sup>	
18	0.8-0.9	3-644508-1
20	0.5-0.6	3-644509-1
22	0.3-0.4	3-644510-1

**Note:** Tyco Electronics does not recommend terminating an MTA contact more than one time. Use replacement contacts when required for field repairs or wire gage changes.

MTA-156  
.156 [3.96]

**MTA-156 IDC Card Edge Connectors—Closed End and Feed-Thru**

**Material and Finish**

**Housing** — UL94V-0 rated, polyester, see chart for color

**Contacts** — Phosphor bronze, post tin plated

**Note:** Refer to pages 70 thru 74 for approved wire listings.

**Color Coding by Wire Size for UL94V-0 Connectors**

- 26 AWG — Blue
- 24 AWG — White
- 22 AWG — Red
- 20 AWG — Yellow
- 18 AWG — Orange

**Connector Ordering Information**

The “Base Part Numbers” Chart at right shows the base part number and number of circuits available for the described connectors.

Prefixes and suffixes are determined by the number of circuit positions in the connector. For example, the complete part number for a 12-position closed end connector without mounting ears for 18 AWG wire would be:

Base number **640859** plus prefix-and-suffix **1- -2**

The correct ordering number is **1-640859-2**

See page 15 for an explanation of RoHS lead free equivalents.

**Performance Data**

**Voltage Rating** — 600 vac

**Current Rating** — 5 amp max.

**Low-Level Resistance** — 7 mΩ max. initial

**Dielectric Withstanding Voltage** — 1250 vac/1 min.

**Insulation Resistance** — 5000 MΩ min. initial

**Operating Temperature** — -55° C to +105° C

**Technical Documents**

**Product Specification**  
108-1058 MTA-156 Card Edge Connectors

**Application Specification**  
114-1020 MTA-156 Connectors, Posted Connectors and Card Edge Connectors



**Base Part Numbers**

Connector Type & Wire Size	Closed End				Feed-Thru			
	Without Mounting Ears		With Mounting Ears		Without Mounting Ears		With Mounting Ears	
	Connector Part Nos.	No. of Circuits/RoHS Equiv.	Connector Part Nos.	No. of Circuits/RoHS Equiv.	Connector Part Nos.	No. of Circuits/RoHS Equiv.	Connector Part Nos.	No. of Circuits/RoHS Equiv.
<b>Standard UL94V-0, Tin Plated</b>								
18 AWG 0.8-0.9 mm <sup>2</sup>	640859	3, 6, 9, 12, 15, 18, 20-24 33, 36, 39, 42, 45, 48, 50-54	640864	3, 6, 9, 12, 15, 18, 20-24 33, 36, 39, 42, 45, 48, 50-54	641283	3, 6, 9, 12, 15, 18, 20-24 33, 36, 39, 42, 45, 48, 50-54	641288	3, 6, 9, 12, 15, 18, 20-24 33, 36, 39, 42, 45, 48, 50-54
20 AWG 0.5-0.6 mm <sup>2</sup>	640860	3, 6, 9, 12, 15, 18, 20-24 33, 36, 39, 42, 45, 48, 50-54	640865	3, 6, 9, 12, 15, 18, 20-24 33, 36, 39, 42, 45, 48, 50-54	641284	3, 6, 9, 12, 15, 18, 20-24 33, 36, 39, 42, 45, 48, 50-54	641289	3, 6, 9, 12, 15, 18, 20-24 33, 36, 39, 42, 45, 48, 50-54
22 AWG 0.3-0.4 mm <sup>2</sup>	640861	3, 6, 9, 12, 15, 18, 20-24 33, 36, 39, 42, 45, 48, 50-54	640866	3, 6, 9, 12, 15, 18, 20-24 33, 36, 39, 42, 45, 48, 50-54	641285	3, 6, 9, 12, 15, 18, 20-24 33, 36, 39, 42, 45, 48, 50-54	641290	3, 6, 9, 12, 15, 18, 20-24 33, 36, 39, 42, 45, 48, 50-54
24 AWG 0.2 mm <sup>2</sup>	640862	3, 6, 9, 12, 15, 18, 20-24 33, 36, 39, 42, 45, 48, 50-54	640867	3, 6, 9, 12, 15, 18, 20-24 33, 36, 39, 42, 45, 48, 50-54	641286	3, 6, 9, 12, 15, 18, 20-24 33, 36, 39, 42, 45, 48, 50-54	641291	3, 6, 9, 12, 15, 18, 20-24 33, 36, 39, 42, 45, 48, 50-54
26 AWG 0.12-0.15 mm <sup>2</sup>	640863	3, 6, 9, 12, 15, 18, 20-24 33, 36, 39, 42, 45, 48, 50-54	640868	3, 6, 9, 12, 15, 18, 20-24 33, 36, 39, 42, 45, 48, 50-54	641287	3, 6, 9, 12, 15, 18, 20-24 33, 36, 39, 42, 45, 48, 50-54	641292	3, 6, 9, 12, 15, 18, 20-24 33, 36, 39, 42, 45, 48, 50-54

No. of Circuits	Dimensions					Prefix/Suffix
	A	B	C	D	E	
3	.500 [12.70]	.926 [23.52]	1.248 [31.70]	.484 [12.29]	.650 [16.51]	-3
6	.968 [24.59]	1.394 [35.41]	1.716 [43.59]	.952 [24.18]	1.118 [28.40]	-6
9	1.436 [36.47]	1.862 [47.29]	2.184 [55.47]	1.420 [36.07]	1.586 [40.28]	-9
12	1.904 [48.36]	2.330 [59.18]	2.652 [67.36]	1.888 [47.96]	2.054 [52.17]	1- -2
15	2.372 [60.25]	2.798 [71.07]	3.120 [79.25]	2.356 [59.84]	2.522 [64.06]	1- -5
18	2.840 [72.14]	3.266 [82.96]	3.588 [91.14]	2.824 [71.73]	2.990 [75.95]	1- -8
20	3.152 [80.06]	3.578 [90.88]	3.900 [99.06]	3.136 [79.65]	3.302 [83.87]	2- -0
21	3.308 [84.02]	3.734 [94.84]	4.056 [103.02]	3.292 [83.62]	3.458 [87.83]	2- -1
22	3.464 [87.99]	3.890 [98.81]	4.212 [106.98]	3.448 [87.58]	3.614 [91.80]	2- -2
23	3.620 [91.95]	4.046 [102.77]	4.368 [110.95]	3.604 [91.54]	3.770 [95.76]	2- -3
24	3.776 [95.91]	4.202 [106.73]	4.524 [114.91]	3.760 [95.50]	3.926 [99.72]	2- -4

MTA-156  
.156 [3.96]



## MTA-156 IDC Card Edge Accessories

### Dust Cover

#### Material (RoHS Compliant)

UL94V-0 rated, polyester, white

Cover is for both Closed End and Feed-Thru connectors



#### Cover Ordering Information

The "Base Part Numbers" Chart at right shows the base part number and number of circuits available for the described cover.

Prefixes and suffixes are determined by the number of circuit positions in the cover. For example, the complete part number for a 12-position dust cover would be:

Base number **641106** plus prefix-and-suffix

**1- -2**

The correct ordering number is

**1-641106-2**

#### Base Part Number

Cover Part No.	No. of Circuits
641106	3, 6, 9, 12, 15, 18, 20-24

No. of Circuits	Dim. A	Prefix/Suffix
3	.504 12.80	-3
6	.972 24.69	-6
9	1.440 36.58	-9
12	1.908 48.46	1- -2
15	2.376 60.35	1- -5
18	2.844 72.24	1- -8
20	3.156 80.16	2- -0
21	3.312 84.12	2- -1
22	3.468 88.09	2- -2
23	3.624 92.05	2- -3
24	3.780 96.01	2- -4

### Replacement IDC Contacts

#### Material and Finish

Phosphor bronze; post tin plated

#### Part Numbers

- 3-640991-1 (18 AWG [0.8-0.9 mm<sup>2</sup>])
- 3-640992-1 (20 AWG [0.5-0.6 mm<sup>2</sup>])
- 3-640993-1 (22 AWG [0.3-0.4 mm<sup>2</sup>])
- 3-640994-1 (24 AWG [0.2 mm<sup>2</sup>])
- 3-640995-1 (26 AWG [0.12-0.15 mm<sup>2</sup>])



### Locking Plugs

#### Material (RoHS Compliant)

UL94V-2 rated, nylon, white

Part Number 641101-1



**Note:** Contact must be removed to install locking plug.

#### Material (RoHS Compliant)

UL94V-2 rated, nylon, white

Part Number 641293-1



**Note:** Contact can remain during locking plug installation.

**.156 [3.96] Centerline SL-156 Crimp Contacts and Housings**

**Product Facts**

- Rugged wire-to-board interconnection to mate with .045 square or round post headers or staked posts on .156 centers
- Standard Connectors accept wire range of 18–24 AWG [0.9–0.2 mm<sup>2</sup>] and LID Connectors accept wire range of 18–24 AWG [0.9–0.2 mm<sup>2</sup>] and a limited 16 AWG [1.29–1.42 mm<sup>2</sup>] (2550–2800 CMA)
- Two-piece interconnection system (connector/header)
- Housing made of flame retardant nylon
- Available in 1- through 24-position connector configurations
- Connectors are end-to-end stackable
- Wire-to-board system offers polarization with friction lock for positive mating
- Meets the material requirements of Table 23.1 of UL1410 Standard for High-Voltage Television Receivers and Video Productions
- Recognized under the Component Program of Underwriters Laboratories Inc., File No. E28476
- Certified by Canadian Standards Association, File No. LR7189



**Technical Documents**

- **Product Specification**  
108-1049, 108-1049-1, 108-1049-2
- **Application Specification**  
114-1021

The AMP SL-156 connectors shown on the following pages are designed to mate with .045 [1.14] square or round post headers or staked posts on .156 [3.96] centers.

The wire-to-board connector is a two-piece connector system with the wire crimped to the contact, then inserted into the housing. This product mates with the MTA-156 flat, polarized and friction lock header, or staked posts (not MTA-156 shrouded headers).

**Performance Data**

- **Voltage Rating** — 250 vac
- **Current Rating** — 10 amp max. at 250 vac
- **Low-Level Resistance** — 3.0 mΩ max. initial
- **Dielectric Withstanding Voltage** — 2000 vac/1 min.
- **Insulation Resistance** — 1000 MΩ min. initial
- **Operating Temperature** — -55° C to +105° C

The Large Insulation Diameter (LID) Contacts and Housings are for use in applications where wire insulation is up to .112 [2.84] in diameter.

These matrixes represent only the housing and header combinations. You also need to consider the plating on the contacts and headers. Gold contacts with gold headers and tin contacts with tin headers.

**Matrix for Tin Plated Part Numbers**

		Headers																											
Housings	Standard	LID	640383	640384	640385	640387	640388	640389	640445	644611	644612	644613	644614	644615	644616	644617	644749	644750	644751	644752	644753	644754	644755	647227	647228	647229	647230	647260	647262
	640250	647401	Y	Y	Y	N	Y	Y	Y	Y	Y	Y	N	Y	Y	Y	Y	Y	Y	Y	Y	Y	Y	N	Y	Y	Y	Y	Y
640251	647400	Y	Y	Y	Y	Y	Y	Y	Y	Y	Y	Y	Y	Y	Y	Y	Y	Y	Y	Y	Y	Y	Y	Y	Y	Y	Y	Y	Y
770849	647402	Y	Y	Y	N	Y	Y	Y	Y	Y	Y	N	Y	Y	Y	Y	Y	Y	Y	Y	Y	Y	N	Y	Y	Y	N	Y	Y

**Matrix for .000030 [0.00076] Gold Plated Part Numbers**

		Headers																							
Housings	Standard	LID	641202	641203	641204	641207	641208	641209	641210	644627	644628	644629	644630	644631	644632	644633	644756	644757	644758	644759	644760	644761	644762		
	640250	647401	Y	Y	Y	N	Y	Y	Y	Y	Y	Y	N	Y	Y	Y	Y	Y	Y	Y	Y	Y	Y	N	
640251	647400	Y	Y	Y	Y	Y	Y	Y	Y	Y	Y	Y	Y	Y	Y	Y	Y	Y	Y	Y	Y	Y	Y		
770849	647402	Y	Y	Y	N	Y	Y	Y	Y	Y	Y	N	Y	Y	Y	Y	Y	Y	Y	Y	Y	Y	N		

**Matrix for .000015 [0.00038] Gold Plated Part Numbers**

		Headers																							
Housings	Standard	LID	641113	641114	641115	641118	641119	641120	641121	644322	644763	644764	644765	644766	644767	644768	644769	647261							
	640250	647401	Y	Y	Y	N	Y	Y	Y	Y	Y	Y	Y	Y	Y	Y	N	Y							
640251	647400	Y	Y	Y	Y	Y	Y	Y	Y	Y	Y	Y	Y	Y	Y	Y	Y								
770849	647402	Y	Y	Y	N	Y	Y	Y	Y	Y	Y	Y	Y	Y	Y	N	Y								

## SL-156 Crimp Contacts and Keying Plugs

### Contacts

#### Material and Finish

.012 [0.3] bright tin plated brass or phosphor bronze; .012 [0.3] pre-tin brass; or .012 [0.3] brass or phosphor bronze with .000030 [0.00076] gold over nickel (see chart)

- All tin-plated contacts are post lubricated to resist fretting corrosion
- Maximum insulation diameter is .105 [2.67]
- Wire range is 18-30 AWG [0.9-0.06 mm<sup>2</sup>]



#### Application Note

Part No. 640252 has a higher mating and unmating force than Part No. 350980 and is recommended to be used only in housings with 1 through 12 positions.

Part No. 350980 can be used in any size housing but is recommended to be used in housings with 13 through 24 positions.

Part No. 770476 is recommended for use in any size housing. Its mating force is similar to Part No. 350980 while unmating force is similar to 640252.

For housings, see pages 60 and 61.

### Keying Plugs

#### Material (RoHS Compliant)

UL94V-2 rated, nylon, natural color



**Keying Plug**  
Part No. 640254-1



**Keying Pin**  
Part No. 640255-1

Wire Size AWG mm <sup>2</sup>	Contact	Material and Finish	Part Numbers	
			Strip	Loose Piece
24-30 0.2-0.06	A	brass, pre-tin plated	641550-1	—
		brass, bright tin plated	640252-1	640706-1
		brass, pre-tin plated	640252-2	640706-2
18-24 0.9-0.2	A	brass, <b>RoHS Compliant</b>	3-640252-1	3-640706-1
		brass, bright tin plated	350980-1	640707-1
		brass, pre-tin plated	350980-2	—
	B	brass, gold plated	350980-3	770258-1
		brass, <b>RoHS Compliant</b>	3-350980-1	3-640707-1
		phosphor bronze, bright tin plated	770476-1	770522-1
	C	phosphor bronze, gold plated	770476-2	770522-2
		phosphor bronze, <b>RoHS Compliant</b>	3-770476-1	3-770522-1

#### Application Tooling

Extraction Tool  
Part No. 90471-1

#### Loose Piece Contacts —

PRO-CRIMPER II Hand Tool  
Part No. 58614-1 (408-4228)  
[For field service use only]  
For CERTI-CRIMP hand tool, contact  
Technical Support.

#### Strip Contacts —

AMP-O-LECTRIC Model "G"  
Termination Machine\*  
Applicator 680211-3  
(Request Catalog 65828)  
AMP-O-LECTRIC Model "K"  
Termination Machine\* Applicator  
466468-2  
AMP-O-MATIC Stripper-Crimper  
Machine\* SCA 466947-1 or 567828-1  
(with CQM) (Request Catalog 65004)  
AMPOMATOR CLS IV+ Lead Making  
Machine\* Applicator 466468-1  
(Request Catalog 82659)

\*Requires applicators. For part numbers, call Technical Support.

## SL-156 Housings—Wire-to-Board

### Housings

#### Material (RoHS Compliant)

UL94V-0 rated, nylon, white

#### Notes:

1. Accepts either .045 [1.14] square or round posts. Housings mate with flat and friction lock headers, or staked posts on .156 [3.96] centers.
2. Housings without ramp, with polarizing tab, available upon request. Minimums may apply.
3. Recommend contact:  
Part No. 640252 for 1 thru 12 positions; Part No. 350980 for 13 thru 24 positions; Part No. 770476 for 1 thru 24 positions.



(A) With Locking Ramp/With Polarizing Tabs



(B) With Locking Ramp/Without Polarizing Tabs



(C) Without Locking Ramp/Without Polarizing Tabs

Note: Dim. A = 0.156 × (No. of Positions - 1) + 0.152

For contacts, see page 59.

For mateability options, see matrix on page 58.

For mating half visuals, for connectors with locking ramp, see pages 46, 47, 48, 50 and 52, (49 and 51 Front Bend Headers only.)

For mating half visuals, for connectors without locking ramp, see pages 46 thru 52.

No. of Positions*	Housing	Description	Part Numbers*
2-24	A	With Locking Ramp and Polarizing Tabs	770849
1-24	B	With Locking Ramp and without Polarizing Tabs	640250
	C	Without Locking Ramp or Polarizing Tabs	640251

\*Base Part Number Prefixes and Suffixes indicate number of contact positions, e.g. 2 Position = 0-xxxxxx-2 and 12 Position = 1-xxxxxx-2.

Note: Housings not for use with LID Contacts. Shown on page 62.

SL-156  
.156 [3.96]

## SL-156 Housings With Through Board Latch

### Housings

#### Material (RoHS Compliant)

UL94V-2 rated, nylon, white

Mates with .045 square or  
round staked posts only.

For contacts, see page 59



Recommended PC Board Cutout  
for .062 [1.57] Thick PC Board

No. of Pos.	Dimensions		Latch Location Centered Between Pos.	Part Number
	A	B		
2	.312 7.92	—	1 and 2	770894-2
3	.468 11.89	—	1 and 2	770894-3
4	.624 15.85	—	2 and 3	770894-4
5	.780 19.81	—	2 and 3	770894-5
6	.936 23.77	—	3 and 4	770894-6
7	1.092 27.74	—	3 and 4	770894-7
8	1.248 31.70	—	4 and 5	770894-8
9	1.404 35.66	1.092 27.74	1 and 2 & 8 and 9	770894-9
10	1.560 39.62	1.248 31.70	1 and 2 & 9 and 10	1-770894-0

Note: Not for use with LID Contacts. Shown on page 62.

SL-156  
.156 [3.96]

## SL-156 Housings and Contacts for Large Insulation Diameter (LID) Wire

### Housings

#### Material (RoHS Compliant)

UL 94V-0 rated, nylon, white

#### Notes:

1. Accepts Standard and LID contacts.
2. Larger opening in housings eases contact insertion when using wires that have large insulation diameters (.100-.112 [2.54-2.84]).
3. Housings are not End-to-End stackable.

For mateability options, see matrix on page 58.

For mating half visuals, for connectors with locking ramp, see pages 46, 47, 48, 50 and 52, (49 and 51 Front Bend Headers only.)

For mating half visuals, for connectors without locking ramp, see pages 46 thru 52.



Note: Dim. A = 0.156 × (No. of Positions – 1) + 0.19

No. of Positions*	Description	Part Numbers*
		Housings with Larger Openings for Oversize Wire
1-24	Without Locking Ramp or Polarizing Tabs	647400
	With Locking Ramp and without Polarizing Tabs	647401 (shown above)
2-24	With Locking Ramp and Polarizing Tabs	647402

\*Base Part Number Prefixes and Suffixes indicate number of contact positions, e.g. 2 Position = 0-xxxxx-2 and 12 Position = 1-xxxxx-2.

### Contacts

#### Material and Finish

.012 [0.3] bright tin plated phosphor bronze; .012 [0.3] phosphor bronze with .000030 [0.00076] gold over nickel (see chart)

- All tin-plated contacts are post lubricated to resist fretting corrosion
- Maximum insulation diameter is .112 [2.85]
- Wire range is 18-24 AWG [0.9-0.2 mm<sup>2</sup>] and a limited 16 AWG [1.29-1.42 mm<sup>2</sup>] (2550-2800 CMA)



Hooded (Dual Wipe)  
(10 Amp Max. Current Rating)

#### Product Specifications

108-1049-1 and 108-1049-2

#### Application Specification

114-1021

#### Application Tooling

Extraction Tool Part No. 90471-1

#### Loose Piece Contacts —

PRO-CRIMPER II Hand Tool

Part No. 91368-1 [18-24 AWG]

Part No. 91369-1 [16 AWG]

(For field service use only.)

For CERTI-CRIMP hand tool, contact Technical Support.

#### Strip Contacts —

AMP-O-LECTRIC Model "G"

Termination Machine\*

Applicator 1385048-3 [18-24 AWG]

Applicator 1385219-3 [16 AWG]

AMP-O-LECTRIC Model "K"

Termination Machine\*

Applicator 1385048-2 [18-24 AWG]

Applicator 1385219-2 [16 AWG]

Wire Size	Material	Plating	Part Numbers For LID* Wire	
			Strip	Loose Piece
18-24 AWG	Phosphor Bronze	Tin	647406-1	647409-1
		Gold	647406-2	647409-2
		RoHS Compliant	3-647406-1	3-647409-1
16 AWG (2550-2800 CMA only)	Phosphor Bronze	Tin	647466-1	647485-1
		Gold	647466-2	647485-2
		RoHS Compliant	3-647466-1	3-647485-1

\*Large Insulation Diameter (.100-.112 [2.54-2.84])

Notes: 1. For information on application tooling, call Technical Support.

2. Can **not** be used with Standard SL-156 Housings, must be used with LID Housings only.

\*For additional part numbers and information contact Technical Support.

## AMP Economy Power (EP) Wire-to-Board Connector System

### Product Facts

- .156 [3.96], .200 [5.08] and .312 [7.92] centerline
- Wire-to-board connectors comprised of plug housings, receptacle contacts for discrete wire, and mating post headers
- Hooded contact designed to accept wire with insulation diameters up to .118 [3.00]
- Positive locking feature built into header back wall
- Locking mechanism on connector housing maximizes retention
- Number of positions: 1 to 11 for .156 [3.96] centerline; 2 to 12 for .200 [5.08] centerline; and 2 to 5 for .312 [7.92] centerline
- Straight, through-hole headers
- Positive latch design for easier mating and unmating
- Polarization tabs help prevent post misalignment and mismatching
- Low-profile mating height of .641 [16.3] for 2 to 11 positions
- Straight headers are end-to-end stackable to conserve PCB space
- Header packaging: bulk pack and tube loaded
- Plug housings and post headers intermateable with JST VH connectors
- Directive 2002/95/EC (RoHS Compliant)
- Recognized under the Component Program of Underwriters Laboratories Inc., File No. E28476 
- Certified by Canadian Standards Association, File No. LR 7189 

### Applications

- Household appliances, garage door openers, power supplies, power connections, or other areas requiring additional connector retention



AMP Economy Power (EP) Connectors are designed for secondary power circuit applications. They consist of wire-to-pc board plug housings (for receptacle contacts) and mating post headers. Three contact centerline spacings are available: .156 [3.96], .200 [5.08] and .312 [7.92].

During mating, the positive locking lever on the outside of the plug housing engages the mating header housing to provide for greater retention. This helps maintain reliable connections, when other non-locking type connectors could vibrate apart. This same locking lever must be depressed to unmate the connectors.

The locking mechanism is also located high enough to help avoid interference with pc board clear plastic coating (potting), which is a common treatment for many home appliances.

Headers with .156 [3.96] centerline are offered in 2 through 11 positions; 2 through 12 positions for .200 [5.08] centerline; and .312 [7.92] centerline are available in 2 through 5 positions. Both versions are provided in bulk pack or in tubes for automatic machines.

The slim, straight, post headers are stackable end-to-end for greater flexibility when designing pc board configurations.

The mating height of a low-profile plug and vertical header is .642 [16.3]; even the 1-position high-profile style measures only .732 [18.6] above the pc board. Compact dimensions like these are well suited for most applications in confined spaces.

### Performance Characteristics

**Voltage Rating** — 250 VAC

**Current Rating** — 7.5 amp max. (2 to 11 pos.), 8 amp max. (1 pos.)

**Low Level Overall Resistance**—  
Initial — 10 mΩ max.

Final — 20 mΩ max.

**Dielectric Withstanding Voltage** —  
1.5 kV AC, 1 min.

**Insulation Resistance** —

Initial — 1000 MΩ min.

Final — 500 MΩ min.

**Durability** — 50 mating and unmating cycles

**Operating Temperature** — -13°F to +221°F [-25°C to +105°C]

**Wire Size Range** — 18-22 AWG  
[0.89-0.30 mm<sup>2</sup>]

**Insulation Diameter** — .118 [3.00] max.

### Technical Documents

**Product Specification**

108-5609

**Application Specification**

114-5253

**Instruction Sheet**

411-5899

**AMP Economy Power (EP) Wire-to-Board Connector System (Continued)**

**Contacts and Plug Housings, Low-Profile**

**Crimp, Snap-in Receptacle Contacts**

**Material and Finish (RoHS Compliant)**

See chart.

**Related Product Data**

**Plug Housings** — Pages 64, 67 and 69



Wire Size Range		Wire Insulation Diameter	Material and Finish	Part Number		Applicator Part Number		
AWG	mm <sup>2</sup>			Strip Form	Loose Piece	AMPOMATOR CLS IV+ Lead Maker Base Part No. 356500	AMP-O-LECTRIC Terminator Model K Part No. 1-471273-3	Model G Part No. 354500-1
18-22	0.89-0.30	.067-.118 1.70-3.00	Phos. Brz., Pre-Tin	1123721-1	1318912-1*	1385286-1	1385286-2	1385286-3
			Brass, Pre-Tin	1123721-2	—			

\* For 18-20 AWG, use Straight Action Hand Tool (SAHT) Part Number 91579-1.

**Plug Housings, Low-Profile**

**Material and Finish (RoHS Compliant)**

**Housing** — UL 94V-0 rated nylon, natural color

**Note:** Alternate colors available upon request. Minimums may apply. Please contact product engineer or product manager for details.

**Related Product Data**

**Contacts** — see above

**Mating Post Headers** — Pages 65 and 66



Number of Positions	Dimension A	Part Number
2	.310 [7.86]	1-1123722-2
3	.465 [11.82]	1-1123722-3
4	.621 [15.78]	1-1123722-4
5	.777 [19.74]	1-1123722-5
6	.933 [23.70]	1-1123722-6
7	1.089 [27.66]	1-1123722-7
8	1.245 [31.62]	1-1123722-8
9	1.401 [35.58]	1-1123722-9
10	1.557 [39.54]	1-1123722-0
11	1.713 [43.50]	1-1123722-1
12	1.878 [47.70]	1-647690-2*

\* Consult Product Drawing for dimensional detail.

AMP EP  
.156 [3.96]



**AMP Economy Power (EP) Wire-to-Board Connector System (Continued)**

**Straight and Right-Angle Low-Profile Post Headers**

**.156 [3.96] Centerline**

**Material and Finish (RoHS Compliant)**

**Housing** — UL 94V-0 rated natural color

**Note:** Alternate colors available upon request. Minimums may apply. Please contact product engineer or product manager for details.

**Post** — Tin-plated brass

**Related Product Data**

**Mating Plug Housings** — Page 64

**Straight**



Number of Positions	Dimension A	Part Number		
		Bulk Pack	Tube Loaded (Pcs. per Tube)	Bulk Pack with Pegs
2	.310 [ 7.86]	1-1123723-2	1-1318300-2 (61)	1744057-2
3	.465 [11.82]	1-1123723-3	1-1318300-3 (40)	1744057-3
4	.621 [15.78]	1-1123723-4	1-1318300-4 (30)	1744057-4
5	.777 [19.74]	1-1123723-5	1-1318300-5 (24)	1744057-5
6	.933 [23.70]	1-1123723-6	1-1318300-6 (20)	1744057-6
7	1.089 [27.66]	1-1123723-7	1-1318300-7 (17)	1744057-7
8	1.245 [31.62]	1-1123723-8	1-1318300-8 (15)	1744057-8
9	1.401 [35.58]	1-1123723-9	1-1318300-9 (13)	1744057-9
10	1.557 [39.54]	1-1123723-0	1-1318300-0 (12)	1-1744057-0
11	1.713 [43.50]	1-1123723-1	1-1318300-1 (11)	1-1744057-1
12	1.871 [47.52]	1-647689-2*	—	1-1744057-2

\* Consult Product Drawing for dimensional detail.

**.156 [3.96] Centerline**

**Material and Finish (RoHS Compliant)**

**Housing** — UL 94V-0 rated nylon, natural color

**Note:** Alternate colors available upon request. Minimums may apply. Please contact product engineer or product manager for details.

**Post** — Tin-plated brass

**Related Product Data**

**Mating Plug Housings** — Page 64

**Right-Angle**



Number of Positions	Dimension A	Part Number
2	.312 [ 7.92]	647676-2
3	.468 [11.88]	647676-3
4	.624 [15.84]	647676-4
5	.780 [19.80]	647676-5
6	.935 [23.76]	647676-6
7	1.091 [27.72]	647676-7
8	1.247 [31.68]	647676-8
9	1.403 [35.64]	647676-9
10	1.559 [39.60]	1-647676-0
11	1.715 [43.56]	1-647676-1
12	1.871 [47.52]	1-647676-2

## AMP Economy Power (EP) Wire-to-Board Connector System (Continued)

### Straight and Right-Angle Low-Profile Post Headers, High Temperature

**.156 [3.96] Centerline**

#### Material and Finish (RoHS Compliant)

**Housing** — UL 94V-0 rated nylon, high temperature, natural color

**Note:** Alternate colors available upon request. Minimums may apply. Please contact product engineer or product manager for details.

**Post** — Tin-plated brass

#### Related Product Data

**Mating Plug Housings** — Page 64

### Straight



Maximum Temperature Rating: 280°C

Recommended PC Board Layout

Number of Positions	Dimension A	Part Number
2	.312 [ 7.92]	1744055-2
3	.468 [11.88]	1744055-3
4	.624 [15.84]	1744055-4
5	.780 [19.80]	1744055-5
6	.935 [23.76]	1744055-6
7	1.091 [27.72]	1744055-7
8	1.247 [31.68]	1744055-8
9	1.403 [35.64]	1744055-9
10	1.559 [39.60]	1-1744055-0
11	1.715 [43.56]	1-1744055-1

### Right-Angle

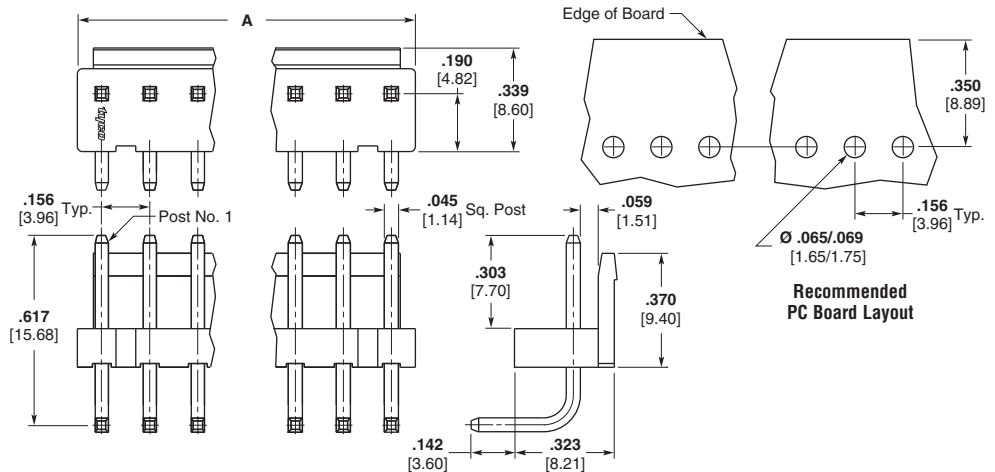

Recommended PC Board Layout

Number of Positions	Dimension A	Part Number
2	.312 [ 7.92]	1744056-2
3	.468 [11.88]	1744056-3
4	.624 [15.84]	1744056-4
5	.780 [19.80]	1744056-5
6	.935 [23.76]	1744056-6
7	1.091 [27.72]	1744056-7
8	1.247 [31.68]	1744056-8
9	1.403 [35.64]	1744056-9
10	1.559 [39.60]	1-1744056-0
11	1.715 [43.56]	1-1744056-1
12	1.871 [47.52]	1-1744056-2

AMP EP  
.156 [3.96]

## AMP Economy Power (EP) Wire-to-Board Connector System (Continued)

### Plug Housings and Post Headers

#### Plug Housings .200 [5.08] Centerline

#### Material and Finish (RoHS Compliant)

**Housing** — UL 94V-0 rated nylon, natural color

**Note:** Alternate colors available upon request. Minimums may apply. Please contact product engineer or product manager for details.

#### Related Product Data

**Contacts** — Page 64

**Mating Post Headers** — See below



Number of Positions	Dimension A	Part Number
2	.353 [ 8.98]	1744036-2
3	.553 [14.06]	1744036-3
4	.753 [19.14]	1744036-4
5	.953 [24.22]	1744036-5
6	1.153 [29.30]	1744036-6
7	1.353 [34.38]	1744036-7
8	1.553 [39.46]	1744036-8
9	1.753 [44.54]	1744036-9
10	1.953 [49.62]	1-1744036-0
11	2.153 [54.70]	1-1744036-1
12	2.353 [59.78]	1-1744036-2

### Post Headers .200 [5.08] Centerline

#### Material and Finish (RoHS Compliant)

**Housing** — UL 94V-0 rated nylon, natural color

**Note:** Alternate colors available upon request. Minimums may apply. Please contact product engineer or product manager for details.

Post—Tin-plated brass



Recommended PC Board Layout

#### Related Product Data

**Mating Plug Housings** — See above



Recommended PC Board Layout

Number of Positions	Dimension A	Part Number	
		Straight	Right-Angle
2	.302 [ 7.68]	1744037-2	1744048-2
3	.502 [12.76]	1744037-3	1744048-3
4	.702 [17.84]	1744037-4	1744048-4
5	.902 [22.92]	1744037-5	1744048-5
6	1.102 [28.00]	1744037-6	1744048-6
7	1.302 [33.08]	1744037-7	1744048-7
8	1.502 [38.16]	1744037-8	1744048-8
9	1.702 [43.24]	1744037-9	1744048-9
10	1.902 [48.32]	1-1744037-0	1-1744048-0
11	2.102 [53.40]	1-1744037-1	1-1744048-1
12	2.302 [58.48]	1-1744037-2	1-1744048-2

**AMP Economy Power (EP) Wire-to-Board Connector System** (Continued)

**Straight Post Headers,  
Low-Profile**

**.312 [7.92] Centerline**

**Material and Finish  
(RoHS Compliant)**

**Housing** — UL 94V-0 rated natural color

**Note:** Alternate colors available upon request. Minimums may apply. Please contact product engineer or product manager for details.

**Post** — Tin-plated brass

**Related Product Data**

**Mating Plug Housings** — Page 64



Number of Positions	Dimension A	Part Number	
		Bulk Pack	Tube Loaded (Pcs. per Tube)
2	.465 [11.82]	1-1123724-2	1-1318301-2 (40)
3	.777 [19.74]	1-1123724-3	1-1318301-3 (24)
4	1.089 [27.66]	1-1123724-4	1-1318301-4 (17)
5	1.401 [35.58]	1-1123724-5	1-1318301-5 (13)

AMP EP  
.312 [7.92]

**Mating Height  
(Low-Profile)**



**AMP Economy Power (EP) Wire-to-Board Connector System (Continued)**

**Plug Housing and Post Header, High-Profile**

**1 Position Plug Housing  
Part Number 1-1123823-1**

**Material and Finish  
(RoHS Compliant)**

**Housing** — UL 94V-0 rated nylon, natural color

**Note:** Alternate colors available upon request. Minimums may apply. Please contact product engineer or product manager for details.



**Related Product Data**

**Contacts** — Page 64

**Mating Post Header** — See below

**1 Position Post Header,  
Straight  
Part Numbers  
1-1123824-1 (Bulk Pack)  
1-1318831-1 (Tube Loaded,  
55 pcs. per Tube)**

**Material and Finish  
(RoHS Compliant)**

**Housing** — UL 94V-0 rated nylon, natural color

**Note:** Alternate colors available upon request. Minimums may apply. Please contact product engineer or product manager for details.

**Post** — Tin-plated brass



**Related Product Data**

**Mating Plug Housing** — See above



**Component Mounting Side**



**Soldering Side**

**Mating Height  
(High-Profile)**



## MTA Wire Selection

Proper wire selection is critical to the success of a wire-to-board application. The chart identifies wires that have been evaluated and approved by the product engineering section. If you plan to use a wire not on the approved list, please submit a sample 12" length of wire to Tyco Electronics for evaluation.

### AWG Metric Equivalents

18—0.8—0.9 mm<sup>2</sup>  
20—0.5—0.6 mm<sup>2</sup>  
22—0.3—0.4 mm<sup>2</sup>  
24—0.2 mm<sup>2</sup>  
26—0.12—0.15 mm<sup>2</sup>  
28—0.08—0.09 mm<sup>2</sup>

### Product Specifications

108-1050 — MTA-100 Connectors  
108-1050-1 — MTA-100 Posted Connectors  
108-1051 — MTA-156 Connectors  
108-1219 — MTA-156 Quad Connector System  
108-1065 — MTA-156 Posted Connectors  
108-1058 — MTA-156 Card Edge Connectors

### Application Specifications

114-1019 — MTA-100 Connectors  
114-1020 — MTA-156 Connectors  
114-1031 — MTA-100 Ribbon Cable Connector Assembly  
114-1032 — MTA-156 Ribbon Cable Connector Assembly  
114-1048 — MTA-156 Quad Connector

### MTA Connectors Approved Wire Listing

MTA-100 Connectors	Wall	Approved Wire AWG
UL 1007 PVC Insulation	.015" [0.381]	22, 24, 26, 28
UL 1061 Semi-Rigid PVC Insulation	.009" [0.229]	22, 24, 26, 28
UL 1095 Semi-Rigid PVC Insulation	.012" [0.305]	24
UL 1371 TEFLON Insulation—TFE	.006" [0.152]	22, 26
UL 1429 Irradiated PVC—X.L.P.V.C.	.010" [0.254]	22, 24, 26, 28
UL 2464 PVC	.013" [0.330]	24
UL 3265 Irradiated Polyethylene—X.L.P.E.	.010" [0.254]	22, 24
UL 3266 Irradiated Polyethylene—X.L.P.E.	.015" [0.381]	22, 24
MIL-W-16878, Type B-PVC Insulation	.010" [0.254]	22
UL 1213 TEFLON Insulation—T.F.E.	.010" [0.254]	22
MTA-156 Connectors		
UL 1007 PVC Insulation	.015" [0.381]	18, 20, 22, 24
UL 1061 Semi-Rigid PVC Insulation	.009" [0.229]	18, 20, 22, 24
UL 1180 TEFLON Insulation—T.F.E.	.015" [0.381]	22
UL 1213 TEFLON Insulation—T.F.E.	.010" [0.254]	18, 22, 24
UL 1316 PVC/Nylon Wall	.015" [0.381]	18, 22
UL 1429 Irradiated PVC—X.L.P.V.C.	.010" [0.254]	18, 20, 22, 24
UL 1430 Irradiated PVC—X.L.P.V.C.	.015" [0.381]	18, 20, 22, 24
UL 1569 PVC	.015" [0.381]	18
UL 3265 Irradiated Polyethylene—X.L.P.E.	.010" [0.254]	22
UL 3266 Irradiated Polyethylene—X.L.P.E.	.015" [0.381]	18, 20, 22, 24

**Note:** When selecting approved wire styles noted on this list, the MTA Application Specifications guidelines must be followed. Also, due to wire variations in insulation wall thickness, hardness and wire stranding we would recommend evaluating the wire selected before final application approval.

TEFLON is a trademark of E.I. DuPont de Nemours and Company.

### MTA-100 Ribbon Cable Preparation



### MTA-156 Ribbon Cable Preparation



† The dimensions shown represent the recommended minimum and maximum for notches; the actual dimension will depend on your application requirements.

#### Notes:

- Cable shall be notched, as indicated in the individual ribbon cable connector assembly drawing, according to the requirements specified in these figures. Conductor shall not be exposed after notching, nor shall individual wire stands be cut or nicked.
- U.L. Style #2651 ribbon cable is approved for use with MTA-100 and MTA-156 connectors per Application Specification 114-1031 and 114-1032.

### Ribbon Cable



## IDC Ribbon Cable

### Product Facts

- Compatible with a variety of Insulation Displacement Connectors
- Available on .025 [0.63], .0394 [1.00], .050 [1.27], .100 [2.54] and .156 [3.96] centerline
- Color code edge mark on conductor #1
- Gray flame retardant flexible PVC insulation
- Insulation rated for temperature of -20°C to +105°C
- Recognized under the Component Program of Underwriters Laboratories Inc.,  
File No. E53793 



Tyco Electronics Corporation has an expanding array of MADISON CABLE planar PVC insulated product designed for compatibility with a variety of Insulation Displacement Connectors. AMP IDC terminations offer a quick, reliable, cost-effective cabling system which can be automated.

The .100 [2.54] centerline cable is available in 28 to 22 AWG, either as tinned or as overcoated tinned wire, in 2 to 28 conductors.

The .156 [3.96] centerline is available in 22 AWG and 18 AWG, either as tinned or overcoated tinned, in 2 to 24 conductors.

IDC Ribbon Cable is produced to tighter standards than usually required for high yield insulation displacement terminations. The extra precision offers uncomplicated operation in fully automatic stripping, notching and termination equipment.

### .050 [1.27] Centerline, IDC Ribbon Cable

#### Product Specifications

**Voltage Rating** — 30 VAC

**Component Recognized by UL to US and Canadian Standards** —  
AWM Style 2651

#### Sizes —

**26 AWG**, 7/34 Tinned copper, PVC insulation (9 – 64 conductors), 500-ft reels (Base AMP Part Number 57034)

**28 AWG**, 7/36 Tinned copper, PVC insulation (9 – 64 conductors), 100-ft reels (Base AMP Part Number 57040) and 500-ft reels (Base AMP Part Number 971111)

**30 AWG**, Other conductor counts available on request. For ordering information, call Toll-Free: **1-877-623-4766** or visit: <http://www.madisoncable.com/fsproducts.htm>

## .100 [2.54] Centerline, IDC Ribbon Cable, PVC Insulation

### Product Specifications

**Voltage Rating** — 300 Volts  
**UL Recognized** — AWM Style 2651  
**CSA** — Available on request



No. of Conductors	Dimensions			Part Number
	A	B	C	
<b>28 AWG 7/32 Tinned Copper</b>				
2	0.100 [2.54]	0.200 [5.08]	0.044 [1.12]	02WIFY00006P
5	0.400 [10.16]	0.500 [12.70]	0.044 [1.12]	05WIFY00006P
10	0.900 [22.86]	1.000 [25.40]	0.044 [1.12]	10WIFY00006P
15	1.400 [35.56]	1.500 [38.10]	0.044 [1.12]	15WIFY00006P
20	1.900 [48.26]	2.000 [50.80]	0.044 [1.12]	20WIFY00006P
25	2.400 [60.96]	2.500 [63.50]	0.044 [1.12]	25WIFY00006P
28	2.700 [68.58]	2.800 [71.12]	0.044 [1.12]	28WIFY00006P

No. of Conductors	Dimensions			Part Number
	A	B	C	
<b>26 AWG 7/34 Tinned Copper</b>				
2	0.100 [2.54]	0.200 [5.08]	0.039 [.99]	02WEY00008P
5	0.400 [10.16]	0.500 [12.70]	0.039 [.99]	05WEY00004P
10	0.900 [22.86]	1.000 [25.40]	0.039 [.99]	10WEY00012P
15	1.400 [35.56]	1.500 [38.10]	0.039 [.99]	15WEY00002P
20	1.900 [48.26]	2.000 [50.80]	0.039 [.99]	20WEY00008P
25	2.400 [60.96]	2.500 [63.50]	0.039 [.99]	25WEY00008P
28	2.700 [68.58]	2.800 [71.12]	0.039 [.99]	28WEY00008P

No. of Conductors	Dimensions			Part Number
	A	B	C	
<b>26 AWG 7/34 Overcoated Tinned Copper</b>				
2	0.100 [2.54]	0.200 [5.08]	0.039 [.99]	02WEY00007P
5	0.400 [10.16]	0.500 [12.70]	0.039 [.99]	05WEY00007P
10	0.900 [22.86]	1.000 [25.40]	0.039 [.99]	10WEY00007P
15	1.400 [35.56]	1.500 [38.10]	0.039 [.99]	15WEY00007P
20	1.900 [48.26]	2.000 [50.80]	0.039 [.99]	20WEY00007P
25	2.400 [60.96]	2.500 [63.50]	0.039 [.99]	25WEY00007P
28	2.700 [68.58]	2.800 [71.12]	0.039 [.99]	28WEY00007P

No. of Conductors	Dimensions			Part Number
	A	B	C	
<b>24 AWG 7/32 Overcoated Tinned Copper</b>				
2	0.100 [2.54]	0.200 [5.08]	0.044 [1.12]	02WIFY00007P
5	0.400 [10.16]	0.500 [12.70]	0.044 [1.12]	05WIFY00007P
10	0.900 [22.86]	1.000 [25.40]	0.044 [1.12]	10WIFY00007P
15	1.400 [35.56]	1.500 [38.10]	0.044 [1.12]	15WIFY00007P
20	1.900 [48.26]	2.000 [50.80]	0.044 [1.12]	20WIFY00007P
25	2.400 [60.96]	2.500 [63.50]	0.044 [1.12]	25WIFY00007P
28	2.700 [68.58]	2.800 [71.12]	0.044 [1.12]	28WIFY00007P

No. of Conductors	Dimensions			Part Number
	A	B	C	
<b>22 AWG 7/30 Tinned Copper</b>				
2	0.100 [2.54]	0.200 [5.08]	0.051 [1.30]	02WGY00001P
5	0.400 [10.16]	0.500 [12.70]	0.051 [1.30]	05WGY00006P
10	0.900 [22.86]	1.000 [25.40]	0.051 [1.30]	10WGY00002P
15	1.400 [35.56]	1.500 [38.10]	0.051 [1.30]	15WGY00006P
20	1.900 [48.26]	2.000 [50.80]	0.051 [1.30]	20WGY00006P
25	2.400 [60.96]	2.500 [63.50]	0.051 [1.30]	25WGY00006P
28	2.700 [68.58]	2.800 [71.12]	0.051 [1.30]	28WGY00006P

Other Conductor Counts Available on Request.

Contact MADISON CABLE (1-877-MADISON), a Division of Tyco Electronics Corporation, for engineering questions or for order placement of this cable.



## .156 [3.96] Centerline, Flat Ribbon Cable, PVC Insulation

### Product Specifications

**Voltage Rating** — 300 Volts  
**UL Recognized** — AWM Style 2651  
**CSA** — Available on request



No. of Conductors	Dimensions			Part Number
	A	B	C	
<b>22 AWG 7/30 Tinned Copper</b>				
2	0.156 [3.96]	0.312 [7.92]	0.051 [1.30]	02WGY00008P
5	0.624 [15.85]	0.780 [19.81]	0.051 [1.30]	05WGY00008P
10	1.404 [35.66]	1.560 [39.62]	0.051 [1.30]	10WGY00008P
15	2.184 [55.47]	2.340 [59.44]	0.051 [1.30]	15WGY00008P
20	2.964 [75.29]	3.120 [79.25]	0.051 [1.30]	20WGY00008P
24	3.588 [91.14]	3.744 [95.10]	0.051 [1.30]	24WGY00008P
<b>18 AWG 7/26 Tinned Copper</b>				
2	0.156 [3.96]	0.312 [7.92]	0.068 [1.73]	02WJY000001P
5	0.624 [15.85]	0.780 [19.81]	0.068 [1.73]	05WJY000010P
10	1.404 [35.66]	1.560 [39.62]	0.068 [1.73]	10WJY000010P
15	2.184 [55.47]	2.340 [59.44]	0.068 [1.73]	15WJY000010P
20	2.964 [75.29]	3.120 [79.25]	0.068 [1.73]	20WJY000010P
24	3.588 [91.14]	3.744 [95.10]	0.068 [1.73]	24WJY000010P

Other Conductor Counts Available on Request.

**Contact MADISON CABLE (1-877-MADISON), a Division of Tyco Electronics Corporation, for engineering questions or for order placement of this cable.**

## Prepared IDC Ribbon Cable



In addition to bulk cable, the US Engineering Cable Assembly Group offers Prepared Cable for the .100 [2.54] and .156 [3.96] centerline cables. This can be in the form of prenotched cable on reels or cut-to-length cable segments.

Prenotched 250 foot reels of cable can be produced with notches at varying increments or repeating all along the cable. The maximum width of these cables

is 20 conductor for the .100 [2.54] centerline and 13 conductor for the .156 [3.96] centerline.

Prepared Cable is also available with a Strip and Retain feature allowing the cable assembly to be soldered directly to the PC Board. This saves space and cost and reduces spare parts inventory. Strip and Retain on both ends is used in family board applications to maintain the

electrical connection when the PC Board is separated into smaller boards after soldering. Widths are limited to 20 conductors for the .100 [2.54] centerline and 13 conductors for the .156 [3.96] centerline. However, multiple cables can be placed side-by-side in a single connector. For other styles and configurations contact the product engineer or product manager.



**MTA Wire Termination Flowchart**

Choose the appropriate MTA Connector from the MTA Catalog 82056.

Select the proper wire style and AWG for the chosen MTA Connector  
(Refer to pages 70-74).

Choose the MTA Termination Tooling (Refer to pages 76-79).

Terminate the Wire-to-MTA Connector per Application Tooling Instruction Sheet.

Inspect the MTA Wire Termination per Application Specification, especially the wire depth. See illustrations: 114-13072 — MTA-50 Connectors, 114-1019 — MTA-100 Connectors, 114-1020 — MTA-156 Connectors, Posted Connector, Card Edge, 114-1048 — MTA-156 Quad Connectors, 114-1031 — MTA-100 Ribbon Cable Connector Assembly, and 114-1032 — MTA-156 Ribbon Cable Connector Assembly.



Connector	A	B
MTA-100	.069-.087 [1.75-2.21]	.040 [1.02]
MTA-156	.090-.113 [2.29-2.87]	.060 [1.52]

Adjust the Termination Tooling (if needed) per Tooling Instruction Sheet  
(repeat the step above).

## MTA Application Tooling Options

### One-At-A-Time Termination Tooling Part Numbers

Note: Max. Insulation Outside Diameter Wire:  
.060 [1.52] for MTA-100 Connectors/.095 [2.41] for MTA-156 Connectors

MTA Connector Assembly	Interchangeable Head		Interchangeable Head and Loose-Piece Feed Track	Interchangeable Head and Tape Feed Track	Special Applicator	T-Handle Maintenance Tool	Notes:
	Manual Hand Tool 58074-1 Air Hand Tool 58075-1 Air Bench Mount Tool 58338-1 Electric Bench Machine 931800-1	Part Number					
MTA-50	Closed End	1583503-1	—	—	—	—	<ol style="list-style-type: none"> <li>A repair kit consists of a cam, a feed-slide sub-assembly and a locating pawl. Repair kits can be made available for other interchangeable heads. Consult Tyco Electronics.</li> <li>Standard modular heads 58246-1 and 58247-1 are recommended for low volume use.</li> <li>Extended wear modular heads 58246-2 and 58247-2 are recommended for high volume use.</li> <li>T-Handle Maintenance Tools are for maintenance (field) use only. They are not recommended for production.</li> <li>Some Manual Hand Tool Assemblies are available:               <ol style="list-style-type: none"> <li>Order 58579-1, comprised of Head 58246-1 with Manual Hand Tool 58074-1.</li> <li>Order 58580-1, comprised of Head 58247-1 with Manual Hand Tool 58074-1.</li> <li>Order 58639-1, comprised of Head 58638-1 with Manual Hand Tool 58074-1.</li> </ol> </li> </ol>
	Feed Thru	58246-1 (Standard)* 58246-2 (Ext Wear) 58246-3 (Ribbon Cable)	—	—	—	—	
MTA-100 Connector	Closed End	933567-1	853546-1 & 853542-1 (Base)	466728-1	59803-1		
	Feed Thru	58442-1	—	—	59803-1		
	Posted (Closed-End)	58638-1	—	—	59803-1		
MTA-156 Connector	Closed End	933568-1	853547-1 & 853542-1 (Base)	466727-1	59804-1		
	Feed Thru	58443-1	—	—	59804-1		
	Posted (Closed-End)	58082-1	—	—	59804-1		
	Closed End	58061-1	—	—	567020-1		
MTA-156 Card-Edge	Closed End	58392-1	—	—	59804-1		

\*Repair Kit 856600-1 \*\*Repair Kit 856600-2

### MTA-50 Mass Termination Tooling Part Numbers

Manual Arbor Frame (with slide) Part Number 1583518-1\*  
Upper Tooling Part Number 1583514-1\*  
Fixture, Discrete Wire, Closed End Part Number 1583515-1 (28-26 AWG)  
Part Number 1583515-2 (30-28 AWG)  
Fixture, Discrete Wire, Feed-Thru Part Number 1583516-1 (28-26 AWG)  
Part Number 1583516-2 (30-28 AWG)  
Fixture, Ribbon Cable, Closed End or Feed-Thru Part Number 1583517-1  
\*Required, plus appropriate Fixture(s).

### MTA-100 and MTA-156 Mass Termination Tooling Part Numbers

Note: Max. Insulation Outside Diameter Wire:  
.050 [1.27] for MTA-100 Connectors/.070 [1.78] for MTA-156 Connectors

MTA Connector Assembly	Interchangeable Head		Harness Board Holding Fixture			Interchangeable Head and Tape Feed Track	
	Part Number	Used With	Part Number	Applicator Assembly	Tooling Assembly	Part Number	Used With
MTA-100 Connector	Closed End	—	58242-1	—	—	854175-1 & 854200-1 (Base)	312522-1
	Feed Thru	58644-1 (Discrete Wire) <sup>†</sup> 58644-2 (Notched Cable) <sup>†</sup>	58074-1 (Man Hd TI)	58243-1	58575-1	—	—
	Closed End (Posted)	—	—	58635-1	58575-1	—	—
	Feed Thru (Posted)	—	—	58636-1	58575-1	—	—
MTA-156 Connector	Closed End	—	—	58244-1	—	854176-1 & 854200-1 (Base)	312522-1
	Feed Thru	58646-1 (Discrete Wire) <sup>††</sup> 58646-2 (Notched Cable) <sup>††</sup>	58074-1 (Man Hd TI)	58245-1	—	—	—
	Card Edge	—	—	58245-3	58576-1	—	—
	Closed End (Posted)	—	—	59848-1	—	—	—
	Feed Thru (Posted)	—	—	59848-3	58576-1	—	—
	Feed Thru (Posted)	—	—	58009-1	—	—	—
MTA-156 Quad	Closed End	—	—	58009-2	58576-1	—	—
	Feed Thru	—	—	58010-2	58576-1	—	—
	Closed End	—	—	58244-1	—	—	—
	Feed Thru	—	—	58244-3	58576-1	—	—
	Feed Thru	—	—	58245-1	—	58024-1 and Tooling Assy 58040-1	—
	Feed Thru	—	—	58245-3	58576-1	58024-1 and Tooling Assy 58040-1	—

<sup>†</sup>2- through 12-positions. <sup>††</sup>2- through 8-positions.

**MTA Application Tooling Options** (Continued)

**One-At-A-Time Termination  
Tooling (Typical Tooling  
Combinations)**



Manual Hand Tool with  
Interchangeable Head



Air Hand Tool with  
Interchangeable Head



Air Bench Mount Tool with  
Interchangeable Head and  
Foot Switch



Electric Bench Machine with  
Interchangeable Head

**Power Units**

**Manual Hand Tool —  
Pistol Grip Handle  
Part No. 58074-1**

- Easy to use
- Ratchet control will not release the trigger until it is fully bottomed
- Head may be rotated for user convenience

**Air Hand Tool —  
Pistol Grip Pneumatic Handle  
Part No. 58075-1**

- Light weight
- Operates at air pressure between 40 and 70 psi [2.76 and 4.83 bar]
- Head may be rotated for user convenience

**Air Bench Mount Tool —  
Bench Mount Power Assembly  
Part No. 58338-1**

- May be mounted with interchangeable head pointed up or down
- Operated by a foot switch
- Operates at air pressure between 40 and 70 psi [2.76 and 4.83 bar]

**Electric Bench Machine —  
IDC Power Unit  
Part No. 931800-1**

- All electric: 120 VAC, 60 Hz, 2 A
- Compact, portable and quiet
- Operated by a foot switch



Air Bench Mount Tool with  
Interchangeable Head and Loose-Piece Feed Track



Electric Bench Machine with  
Interchangeable Head and  
Tape Feed Track



AMP-O-LECTRIC Bench  
Machine with Special Applicator

**Interchangeable Heads and Applicators** (Refer to page 76 for part numbers.)

**Interchangeable Head**

- Terminates one unstripped wire per cycle
- Aligns and holds the connector in place for each termination
- Automatically advances the connector after each termination



**Interchangeable Head and  
Loose-Piece Feed Track**

- No special setup required
- Connectors are easily loaded into feed track
- Connectors are fed using a simple spring-loaded pusher

**T-Handle Maintenance Tool**

**Interchangeable Head and  
Tape Feed Track**

- No special setup required
- Tape-mounted connectors are transferred from product reel to feed track by simply pulling on the free end of the carrier tape
- Connectors are fed using a simple spring-loaded pusher

**Special Applicator**

- Connectors are easily hand loaded into feed track
- Automatically advances the connector after each termination
- Cannot be cycled until the connector is properly positioned

**MTA Application Tooling Options** (Continued)

**Mass Termination Tooling**  
(Typical Tooling Combinations)



Manual Bench Tool with Applicator and Holding Fixture



Air Harness Tool with Applicator



Air Bench Machine



2700 lb Air Bench Machine with Ribbon Cable Notcher Assembly

**Power Units**

**Manual Bench Tool — Arbor Frame Assembly**  
Part No. 58024-1

- Applicator and holding fixture can be oriented for operator convenience for closed-end or feed-thru terminations
- Ram height (insertion depth) is easily adjusted
- May be bench mounted

**Air Harness Tools — Hand-Held Power Unit with Applicator**  
Part No. 58575-1 (MTA-100)  
Part No. 58576-1 (MTA-156)

- Applicator can be rotated 360° for orientation with holding fixture
- Insertion depth is easily adjusted
- Operates at air pressure between 75 and 95 psi [5.17 and 6.55 bar]

**Air Bench Machine — Pneumatic Unit**  
Part No. 91112-2

- Operated by a foot switch
- Operates at air pressure between 80 and 90 psi [5.52 and 6.21 bar]
- Not recommended for notching cable with more than 14 conductors

**2700 lb Air Bench Machine — Part No. 312522-1**

- Operated by a foot switch
- Capable of exerting 2,700 lb [12,000 N] of force at minimum 80 psi [5.52 bar] air pressure
- May be bench mounted

**Applicators and Notcher Assemblies**



Manual Bench Tool with Applicator and Tape Feed Track

**Applicator and Holding Fixture**

- Wires are laced into plastic combs for mass termination
- Trims excess wire for closed-end terminations
- Holding fixture may be mounted to a harness board

**Applicator and Tape Feed Track**

- Tape-mounted connectors are transferred from product reel to feed track by simply pulling on the free end of the carrier tape
- Connectors are fed using a simple spring-loaded pusher
- Feed stop easily adjusted for different connector sizes

**Ribbon Cable Notcher Assembly**

- Notch cable with up to 28 conductors for .100 centerline, and 24 conductors for .156 centerline
- Pressure plate holds cable in position during notching
- Scrap conveniently removed through a chute with a blast of air from a built-in air valve



Ribbon Cable Notcher Assembly

Part Number	Wire Size AWG	Centerline	Used With
854449-2	26-28	.100 2.54	Manual Bench Tool 58024-1
854449-4	22-28	.100 2.54	Air Bench Machine 91112-2
854449-3	18-24	.156 3.96	2700 lb Bench Machine 312522-1 AMP-O-LECTRIC Bench Machine 1-471273-3 (with Conversion Kit 690675-2)

Use Adapter 854468-1 when putting Notcher in the AMP-O-LECTRIC Machine. Use Adapter 854468-2 when putting Notcher in the 2700 lb Air Bench Machine.

## MTA Application Tooling Options (Continued)

### Technical Documents

The following is a list of technical documents covering the installation, operation, adjustment, maintenance and repair of MTA application tooling.

**Instruction Sheets (IS)** provide instructions for assembling or applying the product. They are intended for the Manufacturing Assembler or Operator.

**Customer Manuals (CM)** provide complete, detailed instructions on the installation, operation, adjustment, maintenance and repair of complex tools and application machines.

**Applicator Instructions (AI)** are similar to instruction sheets (which cover products and tools), and provide instructions for installation, adjustment and maintenance of applicators used in automatic and semiautomatic machines.

### Hand Tools, Power Units & Accessories

Manual Arbor Frame (MTA-50)	1583518-1	IS 408-8812	2700 lb Air Bench Machine	312522-1	CM 409-5843
Upper Tooling (MTA-50)	1583514-1	IS 408-8812	Terminator Assembly, "G" Term	354500-1	CM 409-5842
Manual Arbor Frame Assembly	58024-1	IS 408-6923	AMP-O-LECTRIC Bench Machine	1-471273-3	CM 409-5128
Ribbon Cable Applicator, .100	58039-1	IS 408-6685	Conversion Kit	690675-2	IS 408-8022
Ribbon Cable Applicator, .156	58040-1	IS 408-6701	Base Assembly	853542-1	IS 408-9636
Manual Hand Tool	58074-1	IS 408-6790	Base	854200-1	IS 408-9650
Air Bench Mount Tool	58338-1	IS 408-9393	Adapter (AMP-O-LECTRIC)	854468-1	IS 408-9687
Air Hand Tool (MTA-100)	58575-1	IS 408-4260	Adapter (2700 lb Machine)	854468-2	IS 408-9687
Air Harness Tool (MTA-156)	58576-1	IS 408-4260	Repair Kit	856600-1	IS 408-9745
T-Handle Maintenance Tool (MTA-100)	59803-1	IS 408-7907	Repair Kit	856600-2	IS 408-9745
T-Handle Maintenance Tool (MTA-156)	59804-1	IS 408-7907	Electric Bench Mount Tool	931800-1	CM 409-5746
Air Arbor Frame Assembly	91112-2	IS 408-7763			

### One-At-A-Time Termination Tooling

#### Interchangeable Heads

MTA-50		MTA-156	
1583503-1	IS 408-8801	58247-1	IS 408-6930
		58247-2	IS 408-9380
MTA-100		58247-3	IS 408-4146
58246-1	IS 408-6929	58443-1	IS 408-9607
58246-2	IS 408-9379	58061-1	IS 408-6794
58246-3	IS 408-4147	58082-1	IS 408-6795
58442-1	IS 408-9603	58392-1	IS 408-9450
58638-1	IS 408-4358		

#### Interchangeable Head & Loose Piece Feed Track

MTA-100		MTA-156	
933567-1	IS 408-9435	933568-1	IS 408-9466

#### Interchangeable Heads & Tape Feed Track

MTA-100		MTA-156	
853546-1	IS 408-9636	853547-1	IS 408-9637

#### Special Applicators

MTA-100		MTA-156	
466728-1	AI 408-8054	466727-1	AI 408-8054
		567020-1	AI 408-8069

### Mass Termination Tooling

MTA-50		MTA-100		MTA-156		Die Set Assembly	
1583515-1	IS 408-8812	58242-1	IS 408-7994	58009-1	IS 408-7995	854175-1	IS 408-9667
1583515-2	IS 408-8812	58242-3	IS 408-7994	58009-2	IS 408-7995		
1583516-1	IS 408-8812	58243-1	IS 408-7994	58010-2	IS 408-7995		
1583516-2	IS 408-8812	58635-1	IS 408-7994	58244-1	IS 408-7995	854176-1	IS 408-9650
1583517-1	IS 408-8812	58636-1	IS 408-7994	58244-3	IS 408-7995		
		58644-1	IS 408-4406	58245-1	IS 408-7995		
		58644-2	IS 408-4440	58245-3	IS 408-7995		
		59844-1	IS 408-7994	58646-1	IS 408-4405		
		59845-1	IS 408-7994	58646-2	IS 408-4439		
		59845-3	IS 408-7994	59848-1	IS 408-7995		
				59848-3	IS 408-7995		

### Typical Application Rates

#### Produce 6-in. [15 cm] Long Jumpers, One 4-Position MTA-100 Connector per End, Discrete Wire

Method	Terminations Per Hour
Manual Hand Tool 58074-1 with Interchangeable Head 58246-1	—
Electric Bench Machine 931800-1 with Interchangeable Head 58246-1	900
Electric Bench Machine 931800-1 with Interchangeable Head and Loose-Piece Feed Track 933567-1	1,100
Electric Bench Machine 931800-1 with Interchangeable Head and Tape Feed Track 853546-1 and 853542-1 (Base)	1,250

#### Apply One 4-Position MTA-100 Feed-Thru Connector per Assembly, Discrete Wire

Method	Terminations Per Hour
Manual Bench Tool 58024-1 with Applicator and Holding Fixture	650

For further information about tooling call Technical Support.

#### Produce 6-in. [15 cm] Long Jumpers, One 4-Position MTA-100 Connector per End, Ribbon Cable\*

Method	Terminations Per Hour
2700 lb Air Bench Machine 312522-1 with Applicator and Tape Feed Track 854175-1 and 854200-1 (Base)	7,500

\* Procedure: Mass terminate 12-conductor ribbon cable with three connectors per end. After terminating, separate by tearing the 12-conductor assembly into three 4-conductor assemblies.

#### Cable Notching

Method	Cable Ends Per Hour
2700 lb Air Bench Machine 312522-1 with Ribbon Cable Notcher Assembly 854449-2 and 854468-2 (Adapter)	1,000

## Part Number Index

**Note:** This index lists all cataloged parts by base no. only. Complete part nos. (with prefixes and/or suffixes) are shown on the page(s) indicated.

Part No.	Page
02WEY00007P	72
02WEY00008P	72
02WFY00006P	72
02WFY00007P	72
02WGY00001P	72
02WGY00008P	73
02WJY000001P	73
05WEY00004P	72
05WEY00007P	72
05WFY00006P	72
05WFY00007P	72
05WGY00006P	72
05WGY00008P	73
05WJY000010P	73
10WEY00007P	72
10WEY00012P	72
10WFY00006P	72
10WFY00007P	72
10WGY00002P	72
10WGY00008P	73
10WJY000010P	73
15WEY00002P	72
15WEY00007P	72
15WFY00006P	72
15WFY00007P	72
15WGY00006P	72
15WGY00008P	73
15WJY000010P	73
20WEY00007P	72
20WEY00008P	72
20WFY00006P	72
20WFY00007P	72
20WGY00006P	72
20WGY00008P	73
20WJY000010P	73
24WGY00008P	73
24WJY000010P	73
25WEY00007P	72
25WEY00008P	72
25WFY00006P	72
25WFY00007P	72
25WGY00006P	72
28WEY00007P	72
28WEY00008P	72
28WFY00006P	72
28WFY00007P	72
28WGY00006P	72
57034	71
57040	71
350980	59, 60
640250	60
640251	60
640252	59, 60
640383	46
640384	46
640385	47
640387	49
640388	48

Part No.	Page
640389	49
640426	37
640427	37
640428	37
640429	37
640430	37
640431	37
640432	37
640433	37
640434	37
640435	37
640440	15
640441	15
640442	15
640443	15
640445	48
640452	21
640453	21
640454	23
640455	23
640456	24
640457	24
640468	15
640469	15
640470	15
640471	15
640472	37
640473	37
640474	37
640475	37
640476	37
640477	37
640478	37
640479	37
640480	37
640481	37
640550	16
640551	40
640556	41
640557	41
640558	41
640559	41
640595	39
640599	39
640600	39
640601	39
640602	39
640604	39
640605	39
640606	39
640607	39
640608	39
640620	15
640621	15
640622	15
640623	15
640629	42
640630	42
640631	41
640632	41
640633	41
640634	41

Part No.	Page
640635	41
640636	17
640637	17
640638	17
640639	17
640642	16
640643	40
640706	59
640707	59
640708	17
640709	17
640859	56
640860	56
640861	56
640862	56
640863	56
640864	56
640865	56
640866	56
640867	56
640868	56
641101	57
641106	57
641113	46
641114	46
641115	47
641118	49
641119	48
641120	48
641121	49
641122	21
641123	21
641124	23
641125	23
641126	24
641127	24
641143	41
641144	41
641145	41
641146	41
641147	41
641148	37
641149	37
641150	37
641151	37
641152	37
641153	37
641154	37
641155	37
641156	37
641157	37
641168	39
641169	39
641170	39
641171	39
641172	39
641173	39
641174	39
641175	39
641176	39
641177	39
641186	17

Part No.	Page
641187	17
641188	17
641189	17
641190	15
641191	15
641192	15
641193	15
641198	15
641199	15
641200	15
641201	15
641202	46
641203	46
641204	47
641207	49
641208	48
641209	48
641210	49
641211	21
641212	21
641213	23
641214	23
641215	24
641216	24
641217	37
641218	37
641219	37
641220	37
641221	37
641222	37
641223	37
641224	37
641225	37
641226	37
641227	39
641228	39
641229	39
641230	39
641231	39
641232	39
641233	39
641234	39
641235	39
641236	39
641237	15
641238	15
641239	15
641240	15
641241	15
641242	15
641243	15
641244	15
641283	56
641284	56
641285	56
641286	56
641287	56
641288	56
641289	56
641290	56
641291	56
641292	56



**Part Number Index** (Continued)

Part No.	Page	Part No.	Page	Part No.	Page	Part No.	Page
641293	57	643995	45	644574	15	644876	23
641301	39	644020	15	644575	15	644877	23
641302	39	644038	15	644576	15	644878	37
641303	39	644040	15	644577	15	644884	22
641304	39	644042	15	644578	15	644885	22
641305	39	644043	15	644579	15	644886	22
641306	39	644044	15	644611	50	644887	22
641307	39	644082	37	644612	50	644888	22
641308	39	644083	15	644613	51	644889	22
641309	39	644284	37	644614	51	644890	22
641310	39	644312	15	644615	50	644891	22
641311	15	644313	15	644616	50	644892	32
641312	15	644329	55	644617	51	644893	32
641313	15	644370	55	644627	50	644894	32
641314	15	644371	55	644628	50	644896	32
641425	45	644375	55	644629	51	644897	32
641426	45	644376	55	644630	51	644898	32
641427	45	644377	55	644631	50	647000	20
641428	45	644381	55	644632	50	647001	20
641429	45	644382	55	644633	51	647002	20
641435	45	644383	55	644662	37	647003	20
641436	45	644387	55	644663	37	647004	20
641437	45	644388	55	644687	37	647005	20
641438	45	644389	55	644694	22	647006	20
641439	45	644456	22	644695	22	647007	20
641440	42	644457	22	644702	15	647008	20
641522	45	644460	37	644718	39	647009	20
641523	45	644461	37	644720	39	647010	20
641524	45	644462	37	644726	15	647011	20
641525	45	644463	37	644749	46	647012	20
641526	45	644464	37	644750	46	647013	20
641533	42	644465	39	644751	47	647014	20
641534	15	644466	39	644752	48	647015	20
641535	15	644467	39	644753	48	647016	20
641536	15	644468	39	644754	49	647017	20
641537	15	644469	39	644755	49	647018	20
641550	59	644470	39	644756	46	647019	20
641623	42	644471	39	644757	46	647020	20
641643	17	644472	39	644758	47	647021	20
641644	17	644486	30	644759	48	647022	20
641645	17	644487	30	644760	48	647023	20
641646	17	644488	30	644761	49	647030	20
641653	15	644489	30	644762	49	647031	20
641654	15	644497	15	644763	46	647032	20
641655	15	644501	37	644764	46	647033	20
641656	15	644502	37	644765	47	647047	27
641994	17	644508	55	644766	48	647048	27
643067	40	644509	55	644767	48	647050	28
643071	40	644510	55	644768	49	647051	28
643075	16	644511	15	644769	49	647075	27
643077	16	644512	15	644783	37	647076	27
643498	15	644513	15	644791	37	647078	28
643813	15	644514	15	644795	15	647079	28
643814	15	644540	15	644803	30	647106	29
643815	15	644563	15	644807	45	647107	29
643816	15	644564	15	644809	45	647108	29
643817	37	644565	15	644812	45	647109	27
643818	37	644566	37	644814	45	647114	27
643819	37	644567	39	644860	37	647116	28
643820	37	644569	39	644861	30	647117	28
643821	37	644570	39	644874	24	647123	53
643828	15	644572	39	644875	24	647124	53

### Part Number Index (Continued)

Part No.	Page	Part No.	Page	Part No.	Page	Part No.	Page
647125	53	647478	37	1123723	65	1445351	7
647126	53	647479	39	1123724	68	1445352	7
647127	53	647480	15	1123823	69	1445353	7
647128	53	647481	45	1123824	69	1445354	7
647131	53	647485	62	1318300	65	1445355	7
647132	53	647496	39	1318301	68	1445356	7
647133	53	647497	45	1318831	69	1445357	7
647134	53	647609	25	1318912	64	1445358	7
647135	53	647623	25	1375819	31	1445359	5
647136	53	647624	25	1375820	31	1445360	5
647139	53	647625	25	1445120	9	1445361	5
647140	53	647626	25	1445121	10	1445362	5
647141	53	647627	25	1445123	9	1445363	5
647142	53	647628	26	1445124	10	1445364	5
647143	53	647629	26	1445125	9	1445365	5
647144	53	647630	26	1445126	10	1445366	5
647166	29	647646	47	1445169	9	1445367	5
647167	29	647648	52	1445170	9	1445368	5
647168	29	647649	52	1445171	9	1445369	5
647295	28	647651	26	1445172	10	1445370	5
647296	28	647652	26	1445173	10	1445371	5
647297	28	647653	26	1445174	10	1445372	5
647298	27	647676	65	1445336	31	1445373	5
647299	27	647689	65	1445341	7	1445374	5
647300	27	647690	64	1445342	7	1445375	5
647400	62	770258	59	1445343	7	1445376	5
647401	62	770476	59, 60	1445344	7	1744017	48
647402	62	770522	59	1445345	7	1744020	15
647406	62	770849	60	1445346	7	1744036	67
647409	62	770894	61	1445347	7	1744037	67
647466	62	971111	71	1445348	7	1744048	67
647476	45	1123721	64	1445349	7	1744055	66
647477	15	1123722	64	1445350	7	1744056	66

### Application Tooling Part Number Index

Part No.	Page	Part No.	Page	Part No.	Page	Part No.	Page
58009	76, 79	58517	31	91112	78, 79	853547	76, 79
58010	76, 79	58575	76, 78, 79	91579	64	854175	76, 79
58024	76, 78, 79	58576	76, 78, 79	312522	76, 78, 79	854176	76, 79
58039	76, 79	58579	76	354500	79	854200	76, 79
58040	76, 79	58614	59	466468	59	854449	78
58061	76, 79	58635	76, 79	466727	76, 79	854468	78, 79
58074	76, 77, 79	58636	76, 79	466728	76, 79	856600	76, 79
58075	76, 77	58638	76, 79	466747	17	931800	76, 77, 79
58082	76, 79	58639	76	466947	59	933567	76, 79
58242	76, 79	58644	76, 79	471273	78, 79	933568	76, 79
58243	76, 79	58646	76, 79	567020	76, 79	1385286	64
58244	76, 79	59803	76, 79	567373	31	1583503	76, 79
58245	76, 79	59804	76, 79	567827	31	1583514	76, 79
58246	76, 79	59836	17	567828	59	1583515	76, 79
58247	76, 79	59837	41	567910	31	1583516	76, 79
58338	76, 77, 79	59839	76	680211	59	1583517	76, 79
58392	76, 79	59845	79	690675	78, 79	1583518	76, 79
58442	76, 79	59848	76, 79	853542	76, 79		
58443	76, 79	90471	59	853546	76, 79		

## Americas

**Argentina** – Buenos Aires  
Phone: +54-11-4733-2200  
Fax: +54-11-4733-2211

**Brasil** – São Paulo  
Phone: +55-11-2103-6000  
Fax: +55-11-2103-6030

**Chile** – Santiago  
Phone: +56-2-345-0361  
Fax: +56-2-223-1477

**Canada** – Toronto  
Phone: +905-475-6222  
Fax: +905-474-5520  
**Product Information Center:**  
Phone: +905-470-4425  
Fax: +905-474-5525

**Colombia** – Bogota  
Phone: +57-1-319-8959  
Fax: +57-1-319-8960

**Mexico** – Mexico City  
Phone: +52-55-1106-0800  
+01-800-733-8926  
Fax: +52-55-1106-0901

**For Latin/South American Countries not shown**  
Phone: +54-11-4733-2015  
Fax: +54-11-4733-2083

**United States**  
Harrisburg, PA  
Phone: +1-717-564-0100  
Fax: +1-717-986-7575  
**Product Information Center:**  
Phone: +1-800-522-6752  
Fax: +1-717-986-7575  
Troy, MI  
Phone: +1-248-273-3359  
Fax: +1-248-273-3322

## Asia/Pacific

**Australia** – Sydney  
Phone: +61-2-9554-2600  
Fax: +61-2-9502-2556  
**Product Information Center:**  
Phone: +61-2-9840-8200  
Fax: +61-2-9634-6188

**India** – Bangalore  
Phone: +91-80-285-40800  
Fax: +91-80-285-40820

**Indonesia** – Jakarta  
Phone: +65-6482-0311  
Fax: +65-6482-1012

**Japan** – Kawasaki, Kanagawa  
Phone: +81-44-844-8111  
Fax: +81-44-812-3207  
**Product Information Center:**  
Phone: +81-44-844-8013  
Fax: +81-44-812-3200

**Korea** – Seoul  
Phone: +82-2-3415-4500  
Fax: +82-2-3486-3810

**Malaysia** – Selangor  
Phone: +60-3-7805-3055  
Fax: +60-3-7805-3066

**New Zealand** – Auckland  
Phone: +64-9-634-4580  
Fax: +64-9-634-4586

**Philippines** – Makati City  
Phone: +632-848-0171  
Fax: +632-867-8661

**People's Republic of China**  
Hong Kong  
Phone: +852-2735-1628  
Fax: +852-2735-0243  
Shanghai  
Phone: +86-21-2407-1588  
Fax: +86-21-2407-1599

**Singapore** – Singapore  
Phone: +65-6482-0311  
Fax: +65-6482-1012

**Taiwan** – Taipei  
Phone: +886-2-8768-2788  
Fax: +886-2-8768-2268

**Thailand** – Bangkok  
Phone: +66-2-955-0500  
Fax: +66-2-955-0505

**Vietnam** – Ho Chi Minh City  
Phone: +84-8-930-5546  
Fax: +84-8-930-3443

## Europe/Middle East/Africa

**Austria** – Vienna  
Phone: +43-1-905-60-0  
Fax: +43-1-905-60-1333  
**Product Information Center:**  
Phone: +43-1-905-60-1249  
Fax: +43-1-905-60-1251

**Belarus** – Minsk  
Phone: +375 17 237 47 94  
Fax: +375 17 237 47 94

**Belgium** – Kessel-Lo  
Phone: +32-16-352-300  
Fax: +32-16-352-355

**Bulgaria** – Sofia  
Phone: +359-2-971-2152  
Fax: +359-2-971-2153

**Czech Republic and Slovakia**  
**Czech Republic** – Kurim  
Phone: +420-541-162-111  
Fax: +420-541-162-223  
**Product Information Center:**  
Phone: +420-541-162-113  
Fax: +420-541-162-132

**Denmark** – Glostrup  
Phone: +45-43-48-04-00  
Fax: +45-43-44-14-14

**Egypt** – Cairo  
Phone: +202-419-2334  
Fax: +202-417-7647

**Estonia** – Tartu  
Phone: +372-5138-274  
Fax: +372-7400-779

**Finland** – Helsinki  
Phone: +358-95-12-34-20  
Fax: +358-95-12-34-250

**France** – Cergy-Pontoise Cedex  
Phone: +33-1-3420-8888  
Fax: +33-1-3420-8600  
**Product Information Center:**  
Phone: +33-1-3420-8686  
Fax: +33-1-3420-8623

**France Export Divisions** –  
Cergy-Pontoise Cedex  
Phone: +33-1-3420-8804  
Fax: +33-1-3420-8699

**Germany** – Bensheim  
Phone: +49-6251-133-0  
Fax: +49-6251-133-1600  
**Product Information Center:**  
Phone: +49-6251-133-1999  
Fax: +49-6251-133-1988

**Greece** – Athens  
Phone: +30-210-9370-396/397  
Fax: +30-210-9370-655

**Hungary** – Budapest  
Phone: +36-1-289-1000  
Fax: +36-1-289-1010  
**Product Information Center:**  
Phone: +36-1-289-1016  
Fax: +36-1-289-1017

**Ireland** – Dublin  
Phone: +353-1-866-5612  
Fax: +353-1-866-5714

**Israel** – Petach-Tikva  
Phone: +972-3-929-0999  
Fax: +972-3-919-1088

**Italy** – Collegno (Torino)  
Phone: +39-011-4012-111  
Fax: +39-011-4031-116  
**Product Information Center:**  
Phone: +39-011-4012-428  
Fax: +39-011-40-287-428

**Lithuania and Latvia**  
**Lithuania** – Vilnius  
Phone: +370-5-213-1402  
Fax: +370-5-213-1403  
**Product Information Center:**  
Phone: +370-5-211-3016  
Fax: +370-5-213-1403

**Netherlands** – 's-Hertogenbosch  
Phone: +31-73-6246-246  
Fax: +31-73-6212-365  
**Product Information Center:**  
Phone: +31-73-6246-999  
Fax: +31-73-6246-998

**Norway** – Nesbru  
Phone: +47-66-77-88-50  
Fax: +47-66-77-88-55

**Poland** – Warsaw  
Phone: +48-22-4576-700  
Fax: +48-22-4576-720  
**Product Information Center:**  
Phone: +48-22-4576-704  
Fax: +48-22-4576-720

**Romania** – Bucharest  
Phone: +40-21-311-3479/3596  
Fax: +40-21-312-0574

**Russia** – Moscow  
Phone: +7-495-790-7902  
Fax: +7-495-721-1893  
**Product Information Center:**  
Phone: +7-495-790-7902-404  
Fax: +7-495-790-7902-401

**Russia** – St. Petersburg  
Phone: +7-812-718-8192  
Fax: +7-812-718-8193

**Slovenia** – Ljubljana  
Phone: +386-1561-3270  
Fax: +386-1561-3240

**South Africa** – Port Elizabeth  
Phone: +27-41-503-4500  
Fax: +27-41-581-0440

**Spain** – Barcelona  
Phone: +34-93-291-0330  
Fax: +34-93-201-7879

**Sweden** – Upplands Väsby  
Phone: +46-8-50-72-50-00  
Fax: +46-8-50-72-50-01

**Switzerland** – Steinach  
Phone: +41-71-447-0447  
Fax: +41-71-447-0444

**Turkey** – Istanbul  
Phone: +90-212-281-8181/2/3  
+90-212-282-5130/5430  
Fax: +90-212-281-8184

**Ukraine** – Kiev  
Phone: +380-44-206-2265  
Fax: +380-44-206-2264  
**Product Information Center:**  
Phone: +380-44-206-2265  
Fax: +380-44-206-2264

**United Kingdom** –  
Stanmore, Middlesex  
Phone: +44-8706-080208  
Fax: +44-208-954-6234  
**Product Information Center:**  
Freephone (UK only):  
0800-267-666  
Phone: +44-8706-080208  
Fax: +44-208-420-8095

**Tyco Electronics Corporation**  
Harrisburg, PA

82056-10K-MS-FP-6-08-OG3B

